

**Our first 40 years between
innovation and design.**

**Cooking systems
E.ion System
Bellaria
Silence — NRS
No-Drop System
Design
Circle.Tech
Professional**

falmec



**Our first 40 years between
innovation and design.**

**Cooking systems
E.ion System
Bellaria
Silence — NRS
No-Drop System
Design
Circle.Tech
Professional**

falmecc





<p>A —</p> <p>89 Alba 148 Altair 100 Aura</p> <p>B —</p> <p>62 Bellaria 187 Blade 205 Built-in</p> <p>C —</p> <p>98 Cielo 188 Concorde 164 Cover</p> <p>D —</p> <p>115 Dama 177 Diamante 46 Down Draft</p> <p>E —</p> <p>160 Elektra 190 Elios 134 Elle 59 Eolo E.ion 138 Europa 157 Exploit</p> <p>F —</p> <p>178 Flipper 181 Flipper Green Tech 73 Flipper NRS</p> <p>G —</p> <p>192 Ginevra Boston 200 Gruppo Incasso 61 Gruppo Incasso E.ion 202 Gruppo In. Green Tech 204 Gruppo Incasso Murano 81 Gruppo Incasso No-Drop 77 Gruppo Incasso NRS 210 Gruppo Incasso Pro 203 Gruppo In. Touch Vision</p>	<p>L —</p> <p>149 Laguna 116 Levante 132 Light 210 Line Pro 122 Loop 157 Luce 142 Lumen 136 Lumen Island 175 68 Lumen Island 175 NRS 67 Lumen NRS 58 Lumière E.ion 66 Lumina NRS</p> <p>M —</p> <p>160 Manhattan 52 Mare E.ion 54 Marilyn E.ion 209 Marte Pro 118 Materia 186 Mercurio 192 Mimosa 156 Mira 154 Mira Black/White 189 Mizar 32 Modula 198 Move 199 Move Green Tech</p> <p>N —</p> <p>95 Nube 94 Nuvola Led 140 93 Nuvola Led 90</p> <p>P —</p> <p>160 Pharo 40 Piano 144 Plane 70 Plane Black NRS 143 Plane Black/White 145 Plane Green Tech 82 Plane No-Drop 71 Plane NRS 146 Plane Top 151 Polar 152 Polar Black/White 153 Polar Copper/Gold 151 Polar Light 150 Polar X 159 Prestige 168 Prisma</p>	<p>Q —</p> <p>24 Quantum 26 Quantum Easy 172 Quasar 174 Quasar Green Tech 176 Quasar Top</p> <p>R —</p> <p>185 Rialto 51 Rubik E.ion</p> <p>S —</p> <p>36 Sintesi/Sintesi Black 101 Sirio 90 Skema 121 Soffio 126 Sophie 128 Sophie Lamp 108 Spazio 110 Spazio 130 60 Spring E.ion 96 Stella 186 Stream</p> <p>T —</p> <p>170 Tab 56 Twister E.ion</p> <p>V —</p> <p>102 Vega 182 Verso 72 Verso NRS 124 Vetra 196 Virgola 80 Virgola No-Drop 76 Virgola NRS</p> <p>Z —</p> <p>74 Zenith NRS 50 Zephro E.ion 208 Zeus Pro</p>	<p>INDUCTION HOBS</p> <p>43 38 cm Plus</p> <p>ACCESSORIES</p> <p>218 Motors 220 Grease filters 221 Anti-odour filters 226 Filters chart 228 Extensions 229 Conveyers 230 Ducting accessories</p> <p>TECHNICAL NOTES</p> <p>17 Installation types 231 Maintenance 232 Ceiling hood installation 234 Piano hood installation 235 Technical drawings</p> <p>INSTALLATION TYPES</p> <p>86 Ceiling 104 Island 140 Island/Wall 164 Wall 194 Built-in 44 Worktop</p> <p>TECHNOLOGY</p> <p>48 E.ion System 64 Silence NRS 78 No-Drop System 106 Circle.Tech 130 Multi-Air</p>
--	--	---	--

Cooking systems

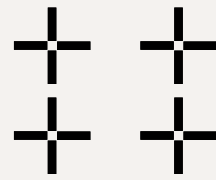

Cooking systems



40 Piano



24 Quantum



26 Quantum Easy **NEW**



32 Modula



36 Sintesi/Sintesi Black

Induction hobs



43 38 cm Plus

Air treatment

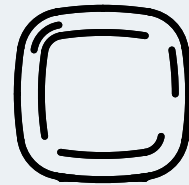

E.ion System

Wall/Island



52 Mare E.ion



54 Marilyn E.ion



51 Rubik E.ion

Island



60 Spring E.ion



59 Eolo E.ion



58 Lumière E.ion



56 Twister E.ion



50 Zephiro E.ion

Built-in



61 Gr. Incasso E.ion

Bellaria

Desktop



62 Bellaria

Hoods

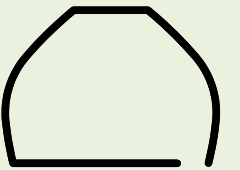

Silence NRS

Wall/Island



66 Lumina NRS



67 Lumen NRS **NEW**



71 Plane NRS

Island



74 Zenith NRS



68 Lumen 175 NRS **NEW**

Wall



73 Flipper NRS



72 Verso NRS



70 Plane Black NRS **NEW**

Built-in



77 Gr. Incasso NRS



76 Virgola NRS **NEW**

No-Drop System

Built-in



80 Virgola No-Drop



81 Gr. Incasso No-Drop **NEW**

Wall/Island



82 Plane No-Drop **NEW**

 Design

Worktop



46 Down Draft

Ceiling



90 Skema

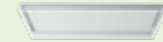

89 Alba



93 Nuvola Led 90 NEW



94 Nuvola Led 140 NEW



95 Nube



96 Stella

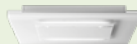

98 Cielo



100 Aura



101 Sirio

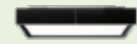

102 Vega

Island /Suspended



108 Spazio



110 Spazio 130



115 Dama

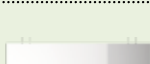

116 Levante



118 Materia



121 Soffio



122 Loop



124 Vetra



126 Sophie



128 Sophie Lamp



132 Light NEW



134 Elle NEW

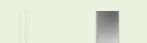

136 Lumen Island 175

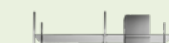

138 Europa

Wall/Island



142 Lumen



143 Plane Black/White



144 Plane



145 Plane GreenTech



146 Plane Top



148 Altair



149 Laguna



150 Polar X NEW



151 Polar Light



151 Polar



152 Polar Black/White



153 Polar Copper/Gold



154 Mira Black/White



156 Mira



157 Luce



157 Exploit



159 Prestige



160 Pharo



160 Elektra



160 Manhattan

 Design

Wall



164 Cover NEW



168 Prisma



170 Tab



172 Quasar



174 Quasar GreenTech



176 Quasar Top



178 Flipper



181 Flipper Green Tech



182 Verso



185 Rialto



177 Diamante



186 Stream



186 Mercurio



188 Concorde



189 Mizar



187 Blade



192 Ginevra Boston



192 Mimosa

Corner

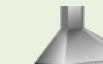

190 Elios

Built-in



200 Gr. Incasso



204 Gr. In. Murano



202 Gr. In. Green Tech



203 Gr. In. Touch Vision



198 Move



199 Move Green Tech



196 Virgola



205 Built-in

 Professional

Wall



208 Zeus Pro

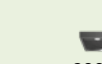

209 Marte Pro

Wall/Island



210 Line Pro

Built-in



210 Gr. Incasso Pro

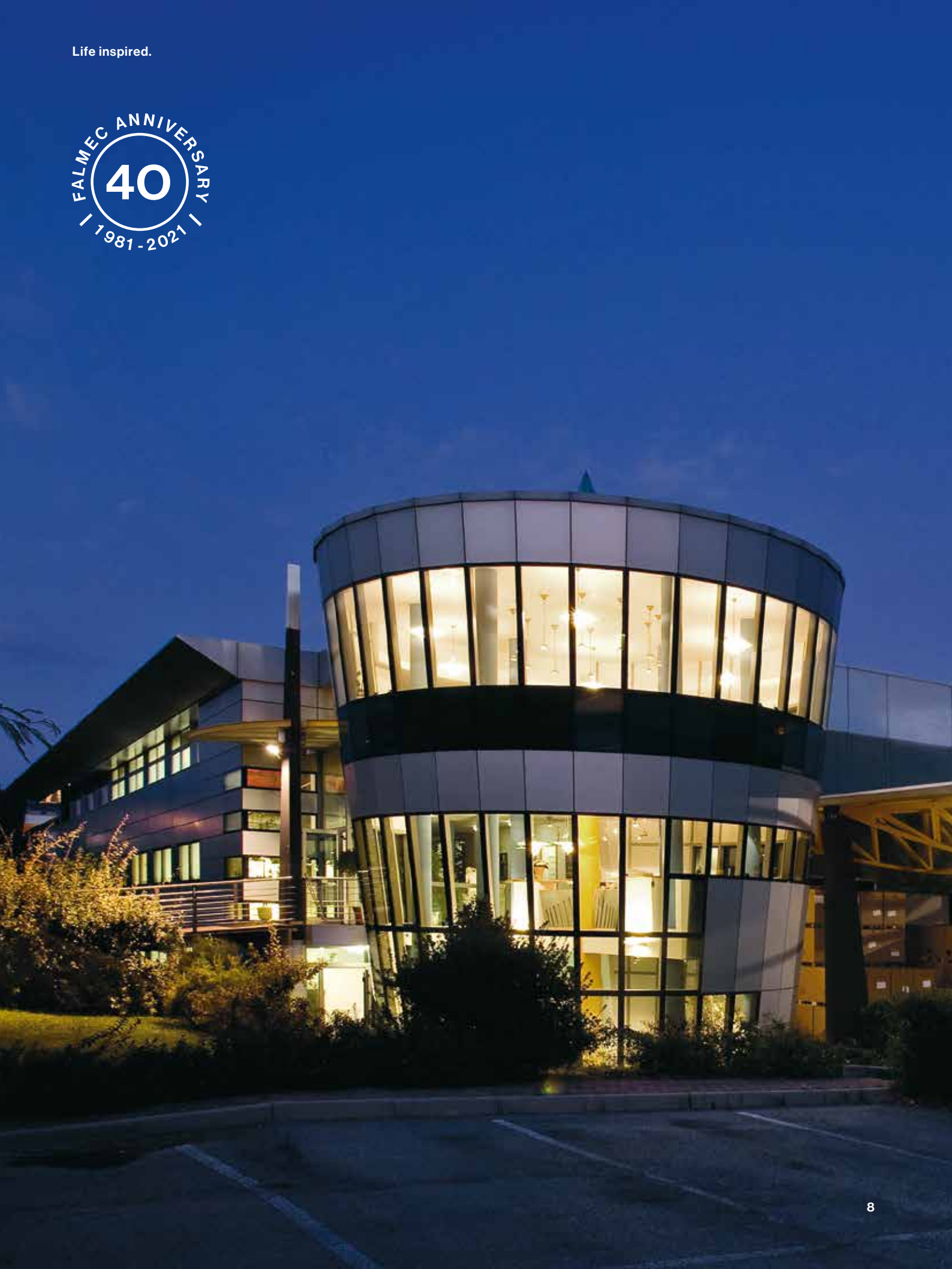

Our first 40 years.

1981-2021: 40 years passed since our journey began. Years of successful dedication, research and growth, along which we have changed, remaining faithful to the values in which we believe and always with the same passion for our work: the driving force behind the success of Falmeccan. Our whole history has a single thread across time, generations, transformations in technology and lifestyles: it is the profound relationship that binds us to those who work with us, our territory as well as those who choose our products.

It is a legacy that comes from our identity as a family business, from our roots in the Italian manufacturing tradition and from the belief that it is possible to continue to grow sustainably, respecting the people and the world that surrounds us. Our innovations originate from this heritage of rural and human values, with an important goal: improving the quality of life and air in our homes.

Today we want to share with you our satisfaction for the achievements and the desire to face new challenges, towards the future.

Thanks to you and to all the people who have lived and continue to live with us this amazing trip.



Short film Falmeccan.
Watch the video

Life inspired.

Why Falmecc.

Solutions for a new quality of life.

A company that, throughout the years, has become increasingly important and well-known in the world of kitchen aspiration systems. A technological and design evolution that lengths across decades and transforms new needs and lifestyles into concrete solutions that can improve the time spent at home.

Falmecc style: perfect balance between aesthetic and function.

The company has been able to develop a real stylistic identity for many years balancing elegance, attention to details and ergonomics, without renouncing to functionality. Thanks to research and collaboration with leading designers, Falmecc gives life to a variety of products designed to interact at best in the most various stylistic contexts and offers the ideal solution for every environment, taste and desire



Life inspired.





Life inspired.

The product's culture.

Constructive excellence.

Falmec projects come into existence within a completely integrated and full quality cycle: from the initial concept to the choice of materials, up to the final product. A constant search for perfection in every production phase that today leads Falmec to be the qualitative reference in the world of extractor hoods.

The real "Made in Italy".

Each Falmec product is designed, developed and made entirely in Vittorio Veneto, near Venice. In this area known as "inox valley", the craft tradition has evolved over the centuries. It led to the creation of one of the most important Italian industrial districts for steel processing. In Falmec the expertise of raw materials merges with unique human abilities and advanced industrial processes. A shared product culture, that is expressed in an amazing balance between creativeness and concreteness, to give life to excellent achievements in which every detail counts.



Life inspired.

Innovation for humans.

Falmec transforms the growing need for a healthy and comfortable environment at home in concrete solutions and products for the five senses: smell, sight, hearing, touch and also for the new cooking solutions which stimulate a different range of tastes. Developed on the basis of decades of experience in the field of aspiration, Falmec's products today reach new goals in order to improve the quality of life at home.

Pure air. Breath well to live better.

Sometimes we do not even notice that within indoor environments the air can be polluted with bacteria, molds, mites and other harmful volatile substances. Falmec offers cutting-edge technological solutions that guarantee people to always live in a feel-good atmosphere, and to breath the freshest air at home.

Silence. The importance of acoustic comfort.

The noise level of the environments in which we live is crucial but often overlooked factor. That's why Falmec has developed a technology that is able to make extractor hoods extremely quiet. NRS (Noise reduction system) reduces noise and makes it imperceptible, allowing people to enjoy the pleasure of cooking and being together.

E.ion™ System 

Carbon.Zeo 

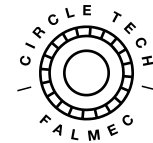

collection
silence



Falmec air solutions.

Choosing the right hood is a fundamental step for the correct design of a kitchen that satisfies every need and aesthetic taste.

The study of the most suitable solution necessarily involves a preliminary assessment of the technical and aesthetic constraints of the kitchen where the hood will be inserted.

Thanks to its expertise in the field of extraction, today Falmec offers multiple technological and aesthetic proposals, suitable for every style and need, always proposing the best option.

Let yourself be inspired by the countless Falmec air solutions!

Types of installation.

Wall.

The wall hood is traditionally the most used option, perfect for optimal fume extraction, if chosen and installed correctly. The wall hood combines functionality and design, often representing a decorative element of separation and customisation of the kitchen.

Built-in.

Built-in hoods, integrated into the wall unit, grant linearity and optimization of the spaces in the kitchen; they are therefore recommended in environments with an essential design or where there is the need to maximize the space on the wall.

Corner.

Corner hoods are the perfect choice in compositions where the cooking area is situated in one of corners of the kitchen. These hoods are traditionally characterised by linear and geometric shapes, easily inserted into different contexts.



Island.

The kitchen is more and more of a convivial space, central to the home project, integrating with the living environment. An Island hood becomes a fundamental element from a functional and design point of view. It performs its function of suction and lighting, adding value and personality to the kitchen itself. Falmecc offers a wide choice of island hoods, with unique solutions, in ducted or recirculating versions, to always guarantee the best air.



Suspended.

Falmecc suspension hoods are distinguished by their unique design, featuring high-quality finishes and materials as well as ambient light to create a unique atmosphere in the kitchen. With no need for pipes or flues, suspension hoods allow complete freedom of installation and significant energy saving. Equipped with innovative filter technology, Falmecc's filter solutions guarantee excellent results when it comes to absorbing odours and improving air quality at home.



Ceiling.

Falmecc's ceiling hoods are designed to fit perfectly into any living environment. Thanks to their clean and minimal shapes and their discreet visual impact, they are suitable for open spaces where the kitchen area integrates with the living space. These solutions collect the cooking fumes that rise naturally and are then captured directly in the ceiling. The hood can be integrated into a false ceiling or installed directly in the ceiling, in recirculating mode.



Integrated cooking systems.

Perfect for minimalist designs where absence of volume is key, Falmecc integrated cooking systems meet the most demanding design requirements, offering extraction efficiency, functionality and ease of installation, both in extraction and recirculation mode, thanks to Carbon.Zeo technology.



These systems feature the intelligent integration of the extractor element within the cooking area, offering two functions in a single product: fumes are collected, captured and filtered at their source. Falmecc models are equipped with an extraction system with an opening flap to enhance aerodynamic air flow, at the same time preserving clean lines.

Down Draft.

The hood is integrated into the worktop, and emerges for use by means of a motorised system. It extracts cooking fumes and vapours near to their source, at the same time lighting the worktop. This system provides great flexibility and versatility when it comes to installation, including different motor options, which can be installed in the hood or in a remote position. To achieve the best results from this type of hood, we advise that it is used with panoramic in-line hobs.





Cooking systems.

Perfect integration, for a new kitchen lifestyle.

Integrated cooking system.

Falmec has designed and created a range of products that integrate cooking and extraction in a single body, inspired by a concept of total minimalism, ergonomics, design and high efficiency. Integrated solutions that incorporate all of the experience by Falmec in extraction, together with cutting-edge cooking technologies, create products in tune with contemporary trends and lifestyles. Fitted with powerful and efficient motors, but at the same time extremely quiet, Falmec integrated cooking systems guarantee optimum performance. Recirculation mode uses exclusive Falmec Carbon.Zeo technology, providing outstanding odour elimination and noticeably reducing cooking vapours.

Flap system.

The Flap System by Falmec is a system of electronic moving flaps, designed to improve the aerodynamics of the incoming air and increase the suction speed of the fumes, captured downwards rather than upwards as in traditional hoods.

Total integration.

Once closed, the flaps disappear totally, for a completely flat and linear work surface, hiding the filters and the operating elements.

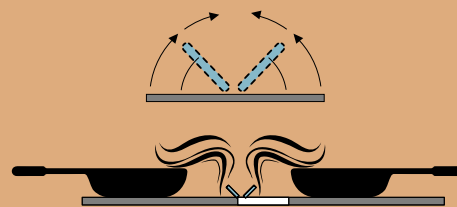



Quantum. Technological elegance.

Quantum, an indivisible element by definition, embodies the concepts of elegance, minimalism and practicality of use. The central extraction section, embellished by a thin frame in matte black steel, ensures a chromatic and aesthetic continuity throughout the cooking area, thus elegantly placing itself in every environment. Designed to ensure maximum effectiveness and practicality, Quantum in "auto" mode automatically adjusts the suction speed according to requirements. The extraction element, composed of two glass flaps that open automatically, optimises the aerodynamics of the incoming air and improves the suction performance, while allowing easy maintenance and cleaning.

Elegance and practicality.

Continuity of colour and materials along the hob is made possible by an extraction system fitted with a glass flap that blends in harmoniously with the cooking area and also allows easy cleaning.

Efficiency and quietness.

A powerful, efficient brushless motor, combined with research into airflow and the use of insulating materials, allows optimum extraction performance with minimum noise.

Easy installation and minimal encumbrance.

Cooking and extraction are enclosed in a single body that allows easy installation. The ducting system, positioned on the rear, also makes it possible to maximise the space in the cabinet.

Optimum filtration with Carbon.Zeo technology.

In the recirculating version, Carbon.Zeo technology provides excellent performance in the reduction of odours and moisture from cooking fumes through the use of Zeolite.

Auto mode.

In this mode, Quantum automatically regulates the extraction power as required, guaranteeing the right ratio between energy consumption and extraction power at all times.

Flex surface.

Thanks to the "Flex surface" technology, the induction works uniformly on all the cooking zones, which can be joined to guarantee maximum versatility in the use of pots of different types and sizes.



Learn more
about Quantum.



Quantum with frame kit KACL.155#NF

Quantum

- Motorised glass flap system
- Schott black ceramic glass
- Black steel extraction area frame with surface scratchproof system
- Brushless motor
- Touch control with display
- Auto mode (suction speed automatically adjusts to cooking power)
- 4 cooking areas with Flex Surface technology
- Double bridge
- 9 cooking levels + Booster
- Pot detection sensor
- Automatic cut-off timer
- Timer/minute minder
- Keep Warm function
- Safety switch off/Safety lock function
- Residual heat indicator
- Metallic filter saturation warning
- Carbon.Zeo filter saturation warning
- Power level management, 3 levels available: 2.8 kw, 3.5 kw, 7.4 kw.

Worktop – 84 cm

Motor and Control

600 m³/h
9 levels + Booster

Energy Class

A+

Filters

Metallic grease filter

Installation

Flush/Half-flush

Sound pressure level

Min. speed

46 dB(A)re1pW

Max. speed

64 dB(A)re1pW

Weight

28 kg

Worktop – 84 cm

600 m³/h

8034122359762

Optional accessories

Kit frame Quantum

Black
KACL.155#NF

Filter: Carbon.Zeo

KACL.930

Filter: cellular charcoal, h60mm

KACL.951

Base grid filter h60 mm

KACL.955

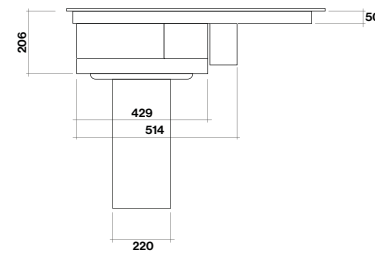

Front view

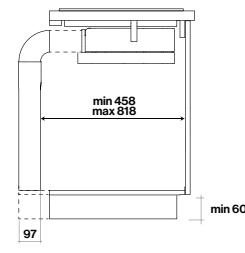

Side view

*recirculating version with KACL.951 (h60) filter

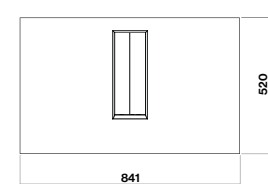

Top view

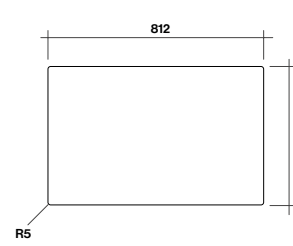

Over top installation
Cutout size

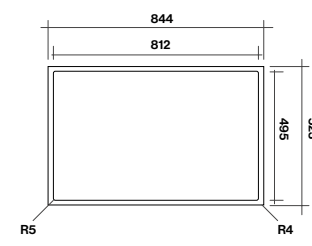

Flush installation
Cutout size

Installation examples:

Installation on a 70 cm top

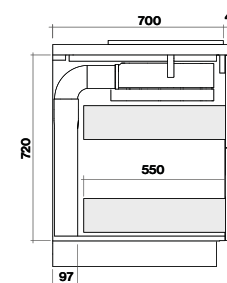

Installation on a 60 cm top

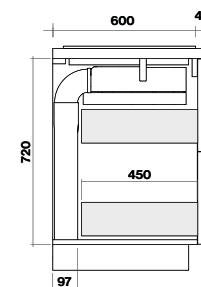

Ducted version*

Rectangular ducting (KACL.352)

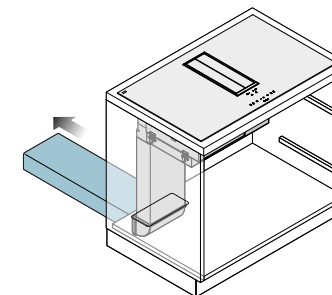

*Ducted version:
socket min. height 100 mm.

Recirculating version**

Under base h60 filter (KACL.951)

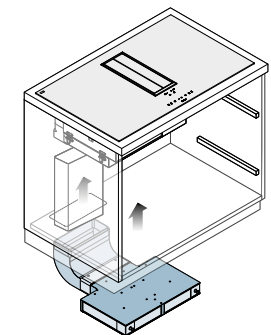

Under base Carbon.Zeo filter (KACL.930)

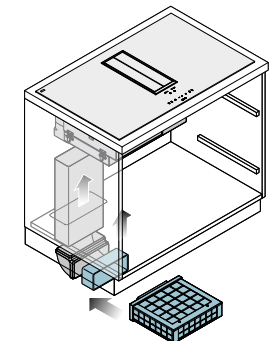

**Recirculating version:
socket min. height 60 mm.

Cooking systems
Quantum Easy

Quantum Easy **NEW**

- Motorised glass flap system
- Schott black ceramic glass
- Black steel extraction area frame with surface scratchproof system
- Carbon.Zeo filter integrated in the hood body
- Rear outlet available
- Anti-noise conveyer included
- Brushless motor
- Touch control with display
- Auto mode (suction speed automatically adjusts to cooking power)
- 4 cooking areas with Flex Surface technology
- Double bridge
- 9 cooking levels + Booster
- Pot detection sensor
- Automatic cut-off timer
- Timer/minute minder
- Keep Warm function
- Safety switch off/Safety lock function
- Residual heat indicator
- Metallic filter cleaning warning
- Carbon.Zeo filter saturation warning
- Power level management, 3 levels available: 2.8 kw, 3.5 kw, 7.4 kw.

Worktop – 84 cm
Motor and Control
 600 m³/h
 9 speed Touch Control
Filters
 Metallic grease filter
Anti-odour filters
 Carbon.Zeo
 KACL.963
Energy class
 A+
Sound pressure level
Min. speed
 46 dB(A)re1pW
Max. speed
 64 dB(A)re1pW

Worktop – 84 cm
 600 m³/h
8034122900292

Optional accessories

Kit cornice Quantum
 Nero
 KACL.155#NF

Design
Falmec Lab

A new type of Quantum hob is now available in an "easy" version. This version incorporates the Filter Carbon.Zeo within the volume of the suction part. The air is then drawn in, filtered and then released directly, filtered and re-emitted directly into the back of the cabinet, inside the sterile space. This implies a faster installation, as there is no need for additional ducts and filtering kits and easier maintenance. The characteristics and dimensions of the standard version of the Quantum remain unchanged. Quantum is equipped with a rectangular tube that can be adjusted in length during installation to adapt to different depths and a deflector connected to the kitchen wall, to optimise the flow of air by reducing turbulence and noise.

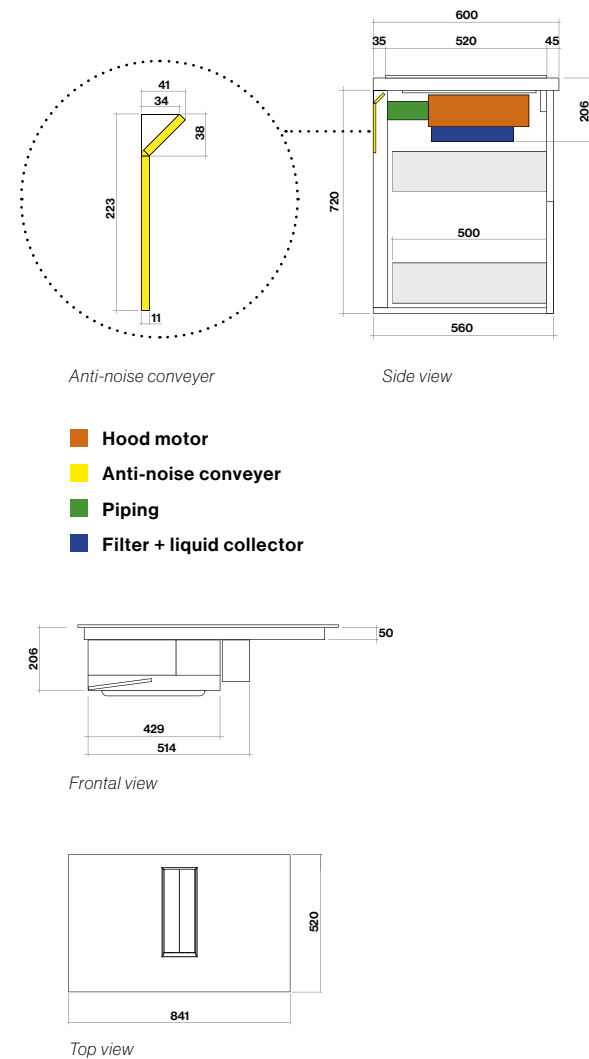

Learn more about
Quantum Easy.

Life inspired.





Modula.

Excellence and modularity.

The name "Modula" perfectly expresses the concept at the core of this project: a modular, integrated cooking and extraction system that can be adapted according to different needs.

This product is available in a range of configurations, creating the perfect combination of cooking and extraction elements. All housed in a steel frame, making it easy to install and clean, and offering a total integration in the worktop.



Modularity and uniqueness.

The concept of modularity, at the core of the "modula" project, responds to the different needs and habits in the kitchen, offering multiple cooking systems, while maintaining the characteristics and advantages of a product conceived as a unique and defined element.

Total integration and the cleanest lines.

The hood is completely integrated into the worktop thanks to a stainless steel frame that surrounds the various cooking modules, and the electronic flap system, which guarantees a completely flat work area, with no joints or other raised elements.

Flex surface.

Thanks to the "Flex surface" technology, the induction works uniformly on all the cooking zones, which can be joined to guarantee maximum versatility in the use of pots of different types and sizes.

The finest materials.

Modula is composed of elements in ceramic glass and steel to create a sharp, geometric and elegant design. The frame and extraction flaps are made of high-quality stainless steel (AISI 304) with a satin Scotch Brite finish, guaranteed to endure every test and to provide long-lasting quality, with exceptional craftsmanship in every detail.

Efficiency and quietness.

A powerful, efficient brushless motor, combined with research into airflow and the use of insulating materials, allows optimum extraction performance with the minimum noise.

Optimum filtration with Carbon.Zeo technology.

In the recirculating version, Carbon.Zeo technology provides excellent performance in the reduction of odours and moisture from cooking fumes through the use of Zeolite.



Learn more
about Modula.





Modula

- Motorised flap system
- Stainless steel AISI 304 frame
- Brushless motor
- Schott black ceramic glass
- Touch control with display
- Cooking areas with Flex Surface technology
- Bridge function
- Teppan cooking plate
- 9 cooking levels + Booster
- Pot detection sensor
- Automatic cut-off timer
- Timer/minute minder
- Keep Warm function
- Safety switch off/Safety lock function
- Residual heat indicator
- Metallic filter saturation warning
- Carbon.Zeo filter saturation warning

Optional accessories

- Filter:** Carbon.Zeo
KACL.930
Filter: cellular charcoal h60 mm
KACL.951

- Base grid** filter h60 mm
KACL.955

Modula/M2
Worktop - 84 cm
Motor and Control
600 m³/h (Brushless)
9 levels + booster

Energy Class
A+

Filters
Metallic grease filter

Installation
Flush/Half-flush

Sound pressure level

Min. speed
46 dB(A)re1pW

Max. speed
64 dB(A)re1pW

Weight
38 Kg

Worktop - 84 cm
600 m³/h
8034122359625

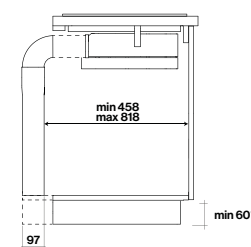

Side View

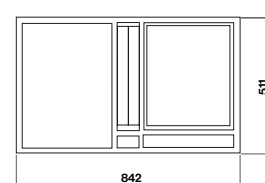
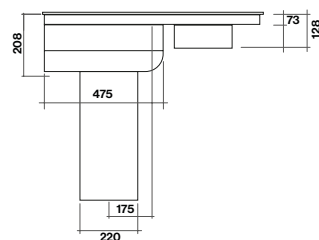

Modula M2:
Teppanyaki +
38 cm Induction Hob

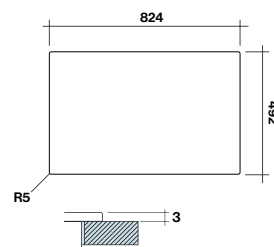

Cut-out size,
over top installation

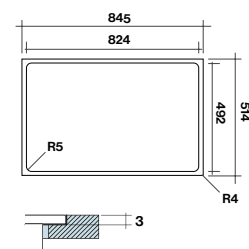

Cut-out size,
flush installation





Sintesi.

The synthesis of excellence.

Sintesi features a clean, geometric design where no detail is superfluous. A solution completely integrated into the worktop with extraction equipment concealed in the rear section. This brings greater practicality to the cooking area and at the same time maximises the space available within the kitchen units. Sintesi ensures maximum quietness and energy efficiency using an innovative brushless motor. A product that combines depth of experience and "know-how" in the field of extraction with cutting-edge cooking technology, representing the synthesis of "Made in Falmecc" excellence.

Rear extraction.

Cooking fumes are extracted from the rear area, along the different cooking zones.

Total integration.

The hood is completely integrated within the worktop thanks to flush installation and folding flaps, to leave a completely flat work surface with no ridges or other raised elements.

Efficiency and quietness.

A powerful, efficient brushless motor, combined with research into airflow and the use of insulating materials, allows optimum extraction performance with the minimum noise.

Ease of installation and best use of space.

Cooking and extraction are combined in a single element, making installation easy, with no need to adapt the hob or use sealants for flush installation. The hood develops vertically, in the rear section, maximising the space available in the kitchen cabinets.

Uniform cooking surfaces.

A flat, streamlined surface, with no raised elements, for more practical cooking on different zones and easier cleaning.

Optimum filtration with Carbon.Zeo technology.

In the recirculating version, Carbon.Zeo technology provides excellent performance in the reduction of odours and moisture from cooking fumes through the use of Zeolite.

Auto mode.

In this mode, Sintesi automatically regulates the extraction power as required, guaranteeing the right ratio between energy consumption and extraction power at all times.

Flex surface.

Thanks to the "Flex surface" technology, the induction works uniformly on all the cooking zones, which can be joined to guarantee maximum versatility in the use of pots of different types and sizes.



Learn more
about Sintesi.



Sintesi/Sintesi Black

- Motorised flap system
- Stainless steel AISI 304 frame or steel with scratch-resistant matt black treatment
- Brushless motor
- Schott black ceramic glass
- Auto mode (suction speed automatically adjusts to cooking power)
- Touch control with display
- 4 cooking areas with Flex Surface technology
- Double bridge
- 9 cooking levels + Booster
- Pot detection sensor
- Automatic cut-off timer
- Timer/minute minder
- Keep Warm function
- Safety switch off/Safety lock function
- Residual heat indicator
- Metallic filter saturation warning
- Carbon.Zeo filter saturation warning

Worktop – 90 cm
Size
 88 x 51 cm
Motor and Control
 600 m³/h - 9 speed + booster
Filters
 Metallic Grease Filter
Installation
 Flush/Half-flush
Energy Class
 A++
Max. Power
 150 W (suction)
Sound pressure level
Min. speed
 48 dB(A)re1pW
Max. speed
 66 dB(A)re1pW
Weight
 29 Kg

Worktop – 90 cm
 600 m³/h
8034122358918
Worktop – 90 cm
 Black - 600 m³/h
8034122900278

Optional accessories

Filter: Carbon.Zeo
 KACL.930
Filter: cellular charcoal h60 mm
 KACL.951
Base grid filter h60 mm
 KACL.955

Stainless Steel/Black Mat

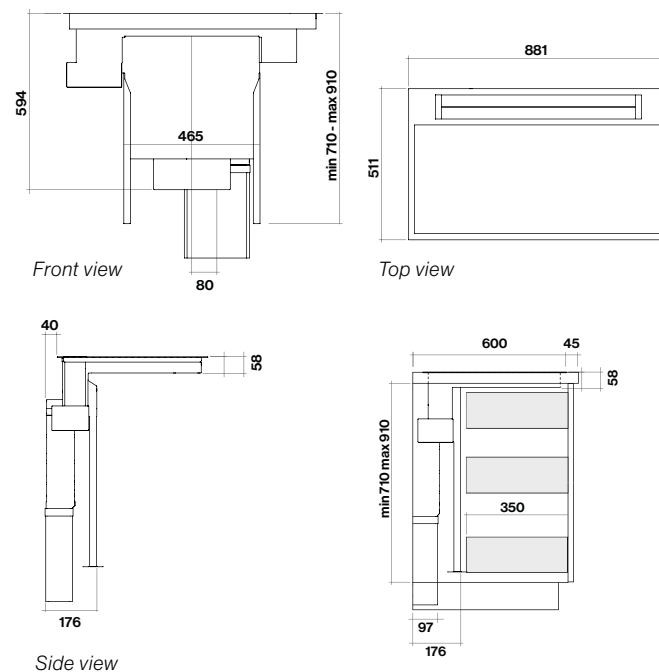

Examples:

Ducted version
 socket min. height 100 mm.

Recirculating version
 socket min. height 60 mm.

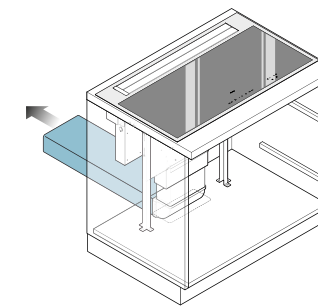

Rectangular ducting
(KACL.352)

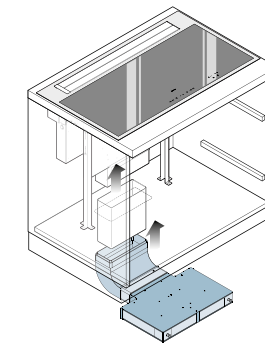

Under base h60 filter
(KACL.951)

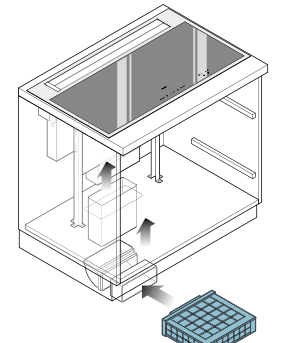

Under base Carbon.Zeo filter
(KACL.930)

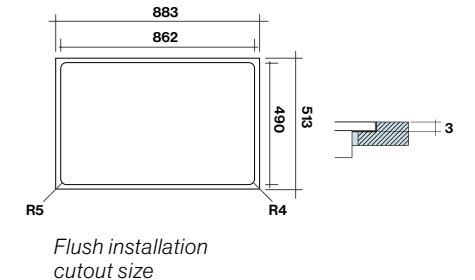
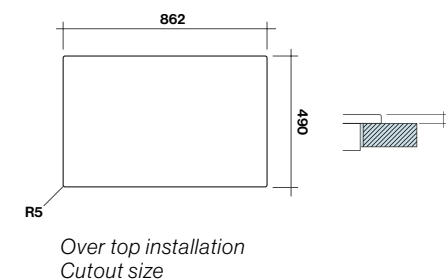



Piano.

Professional feeling.

Piano, designed as a standalone extraction element, offers maximum flexibility in the choice of cooking elements depending on your needs and preferences in the kitchen. Distinguished by its industrial design and professional edge conferred by the AISI 304 steel extraction element.

Maximum freedom.

Piano is designed as a standalone extraction element, for use with any induction hob, and guarantees maximum versatility and adaptability in your choice of worktop.

Stainless charm.

Piano is composed entirely of high-quality stainless steel (AISI 3014) with a satin Scotch Brite finish, guaranteed to endure every test and to provide long-lasting quality, with exceptional craftsmanship in every detail, in keeping with Falmecc's 'Made in Italy' tradition.

More installation possibilities.

Piano can be installed flush or set on top of your worktop, with the motor positioned at the base of the worktop or in a remote position. This allows greater flexibility in the design and the best possible use of the available space, whatever the size and style of your kitchen.

Optimum extraction with Carbon.Zeo technology.

In the filter version, Carbon.Zeo technology provides excellent performance in the reduction of odours and moisture from cooking fumes through the use of Zeolite.



Learn more
about Piano.



Piano

- AISI 304 stainless steel, Scotch Brite finish
- Adjustable flaps
- Oil collector
- Touch control
- Stainless steel filter
- Optional regenerable combine Carbon.Zeo filter
- Piano can be installed only when using induction hobs

Optional accessories

Filter: Carbon.Zeo
KACL.930

Piano
Single element
Motor and Control
1000 m³/h
3 spd + boost, touch control
Power
150 W (suction)
Filters
Carbon.Zeo filter (optional)
Energy Class
B
Sound pressure level
Min. speed
62 dB(A)re1pW
Max. speed
71 dB(A)re1pW
Weight
15 kg

Worktop – Single element
1000 m³/h
8034122354859

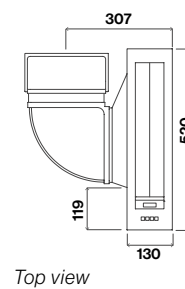
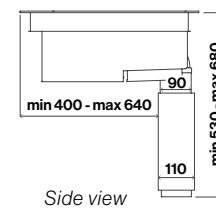
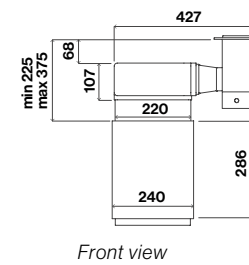

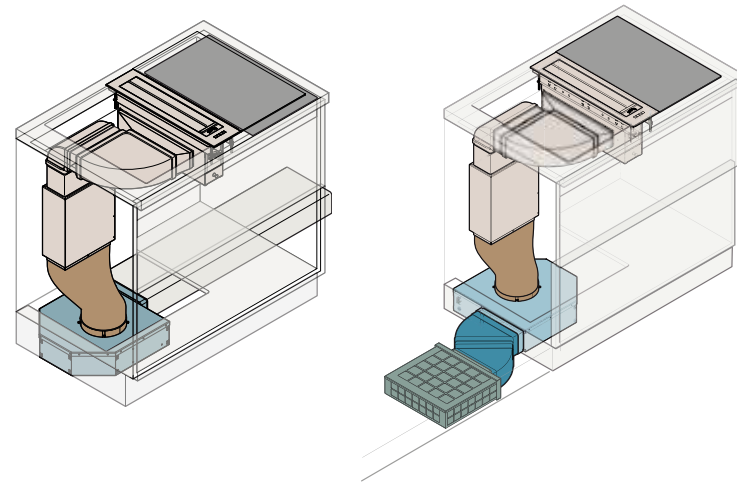

Installation Examples.

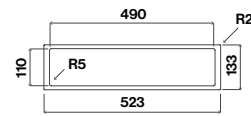

Cut-out size
Flush installation

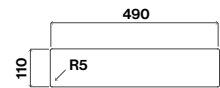

Cut-out size
Over top installation

Configuration 01
Ducted version
Single element
Right air outlet

Hood body
8034122354859

Right outlet junction
KACL.761
8034122710266

1000 m³/h motor
KACL.701#41F
8034122710044

Configuration 02
Recirculating version
Single element
Left air outlet

Hood body
8034122354859

Left outlet junction
KACL.760
8034122710259

1000 m³/h motor
KACL.701#41F
8034122710044

Double horizontal elbow
KACL.345
8034122710396

Carbon.Zeo Under base filter kit
KACL.930
8034122708324

For a complete list of ducting accessories, see page 230.
For more information on the installation, see page 234.



Induction hob - 38 cm Plus

- 2 cooking zones with Full Power technology
- Bridge function
- Schott black glass
- Slider touch controls with red Led display
- Easy installation system
- 9 cooking levels + Power function (Over Boost)
- Automatic switch-on function (fast heating up)
- Pan detector sensor
- Automatic cut-off timer
- Timer/minute minder
- Pause function
- Recall function
- Keeping warm function on 3 temperature levels: 42° keeping/70° food defrosting/94° intermediate cooking (pre boiling)
- Safety switch-off/safety lock function
- Residual heat indicator

Induction hob - 38 cm (Plus)

Size
38 x 52 cm
Voltage/Frequency
220-240V 50/60 Hz
Max. power
3,7 kW
Power cord
1,8 m
Installation
Flush/half flush
Weight
7 Kg

Induction - 38 cm (Plus)
8034122900186

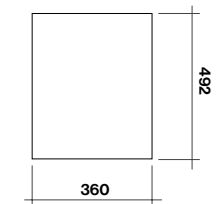
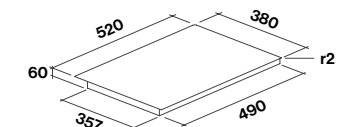

Cut-out size
Over top installation

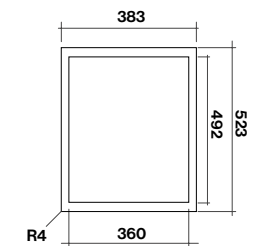

Cut-out size
Flush installation

Worktop. Down Draft.

The hood is integrated into the worktop, and emerges for use by means of a motorised system. It extracts cooking fumes and vapours near to their source, at the same time lighting the worktop. This system provides great flexibility and versatility when it comes to installation, including different motor options, which can be installed in the hood or in a remote position.

To achieve the best results from this type of hood, we advise that it is used with panoramic in-line hobs.





Down Draft

- Scotch Brite stainless steel (AISI 304)
- Tempered white or black glass or steel panel
- Perimeter suction
- Touch control + 24 h function
- Led lighting
- Top filter removable and washable
- Motor not included

Available motors

- KACL.798#41F**
Motor 950 m³/h
- 8034122709833**
KACL.784#46F
Slim motor 800 m³/h
- 8034122708218**
KACL.770#41F
Motor brushless 1100 m³/h
- 8034122710211**
KACL.797#4AF
Motor 1300 m³/h
- 8034122709628**
KACL.786#41F
External extractor 1000 m³/h
- 8034122707433**
KACL.796#4AF
External extractor 1500 m³/h
- 8034122709611**

Falmec recommends using this hoods with panoramic hobs.

Ducted version 90/120 cm
Motor
See available range below
Control
3 spd + boost, touch control
Lighting
Led stripe 14 W (5500 K)
Energy Class
90 cm, 950 m³/h: B
120 cm, 950 m³/h: C
Sound pressure level
Min. speed
51 dB(A)re1pW
Max. speed
64 dB(A)re1pW
Minimum distance from cooker top
60 mm
Weight (without motor)
90 cm version: 37 kg
120 cm version: 44 kg

Recirculating version 90/120 cm
Motor
Slim Motor
Control
3 spd + boost, touch control
Lighting
Led stripe 14 W (5500 K)
Energy Class
600 m³/h: C
Sound pressure level
Min. speed
50 dB(A)re1pW
Max. speed
60 dB(A)re1pW
Minimum distance from cooker top
60 mm
Weight (without motor)
90 cm version: 37 kg
120 cm version: 44 kg

Down Draft – 90 cm
White
8034122348087
Down Draft – 90 cm
Black
8034122348100
Down Draft – 90 cm
Steel
8034122348094
Down Draft – 120 cm
White
8034122348544
Down Draft – 120 cm
Black
8034122348551
Down Draft – 120 cm
Steel
8034122348582

Optional accessories

Filter: Carbon.Zeo underbase KACL.930
Filter: cellular charcoal h60 KACL.951

Base grid filter h60 KACL.955

Remote control 105080053

Upper panel finish:
White/Black/Steel



Setup examples.

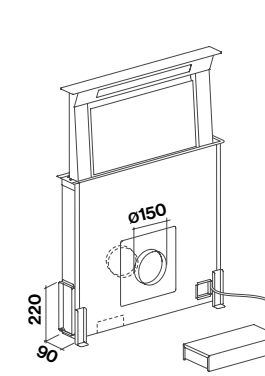

Ducted version (onboard 950 m3/h motor)

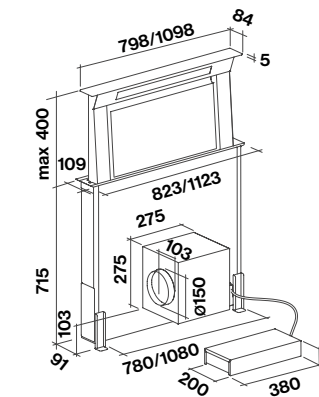

Side view, motor on the front

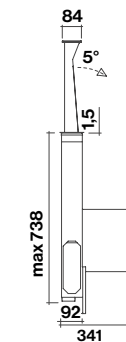

Side view, motor on the back

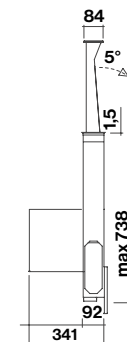

Re-circulation version (Slim motor) with Carbon.Zeo Under base filter (KACL.930)

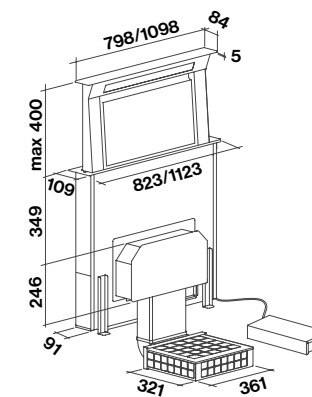

Cut-out size
90 cm: 98 mm x 810 mm
120 cm: 98 mm x 1110 mm

Side view, Slim motor on the front

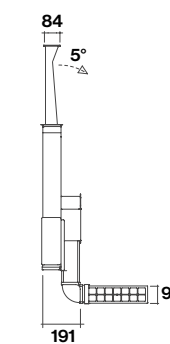

Side view, Slim motor on the back

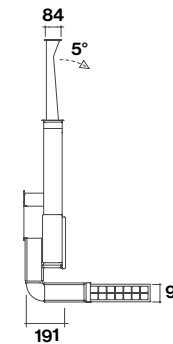

Side view, Slim motor on the back, Under base slim filter KACL.951 h60

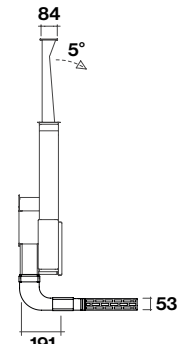

Base board grid, included in the filter kit KACL.930

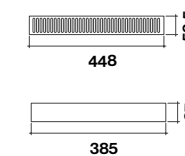

Cut-out size

Base board grid, for use with filter KACL.951 h60 (optional)

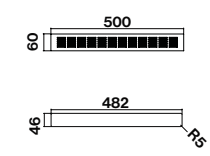

Cut-out size

E.ion System.

The only hoods that purify the air.

Falmec offers unique technology that allows you to recreate an ionic atmosphere in your kitchen, by means of controlLed bipolar ionisation.

Ionic atmospheres naturally eliminate unpleasant odours and also re-establish optimal ionic equilibrium, with noticeable benefits for your physical and psychological wellbeing.



No ozone emission



Bacteria



Cigarette smoke



Mould and fungus



Unpleasant odours



Viruses



Spores and allergen

A sensor that measures air quality.

E.ion System hoods have a specially-developed sensor in the shape of the leaf to detect the presence of volatile organic compounds (VOCs), odorous gases, formaldehyde, cigarette smoke and all other pollutants found in the air. It is therefore an excellent indicator for measuring air quality in your home. This information is indicated by the colour of the leaf which gradually turns from yellow to green as the atmosphere improves.



Automatic mode.

Thanks to the automatic function, whenever the sensor detects a deterioration in air quality in your home, the hood activates automatically, purifying and sanitising the air.

Certified efficiency.

ControlLed bipolar technology and its adaptation for Falmec extraction systems are protected under international patent and certification by independent bodies. Tests carried out at the Universities of Udine and Milan according to standard Uni 13725:2004 have demonstrated a certifiable reduction of up to 95% of unpleasant odours.



POLITECNICO MILANO 1863

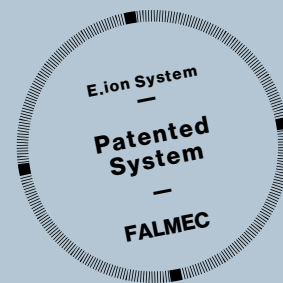

Learn more about E.ion System



Emo Design



Design Studio Rigo

Zephiro E.ion

- White glass satin finish
- Ionising system for air purification
- Perimeter suction with tempered glass panel
- Touch control + air quality indicator
- Automatic mode
- Led lighting
- Combined regenerable Carbon.Zeo filter
- Top filter removable and washable

Optional accessories

Wire rope: Adjustable up to 240 cm steel KACL.140

Island – 67 cm
Motor and Control
 450 m³/h
 3 spd + boost, touch control + leaf sensor
Anti-odour filters
 Carbon.Zeo filter
 101078810
Lighting
 Led 4x1,2 W (3200 K)
Sound pressure level
Min. speed
 56 dB(A)re1pW
Max. speed
 63 dB(A)re1pW
Minimum distance from cooker top
 Gas hob: 60 cm
 Electric hob: 52 cm
Weight
 32 kg

Island – 67 cm
 White – 450 m³/h
8034122347073

Satin white glass

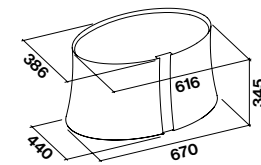

Painted white ceiling support, adjustable up to 110 cm steel wire rope included.

Rubik E.ion

- White or black tempered glass
- Ionising system for air purification
- Perimeter suction with tempered glass panel
- Touch control + air quality indicator
- Automatic mode
- Led lighting
- Combined regenerable Carbon.Zeo filter
- Top filter, removable and washable

Optional accessories

Wire rope: Adjustable up to 240 cm steel KACL.140

Wall – 42 cm
Island – 42 cm
Motor and Control
 450 m³/h
 3 spd + boost, touch control + leaf sensor
Anti-odour filters
 Carbon.Zeo filter
 101078810
Lighting
 Led 4x1,2 W (3200 K)
Sound pressure level
Min. speed
 56 dB(A)re1pW
Max. speed
 63 dB(A)re1pW
Minimum distance from cooker top
 Gas hob: 60 cm
 Electric hob: 52 cm
Weight
 Wall version: 35 kg
 Island version: 32 kg

Wall – 42 cm
 White – 450 m³/h
8034122347967
Wall – 42 cm
 Black – 450 m³/h
8034122347974

Island – 42 cm
 White – 450 m³/h
8034122347035
Island – 42 cm
 Black – 450 m³/h
8034122347042

White glass/Black glass

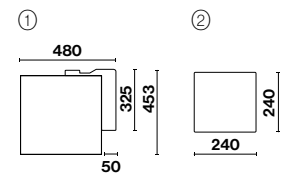
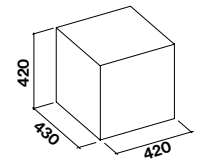

1 - Support for wall version
 2 - Painted white ceiling support for island version, adjustable up to 110 cm steel wire rope included.



Design Pareschi-atelierP

Mare E.ion

- White or black glass
- Ionising system for air purification
- Perimeter suction with tempered glass panel
- Touch control + air quality indicator
- Automatic mode
- Led lighting
- Combined regenerable Carbon.Zeo filter
- Top filter removable and washable

Optional accessories

Wire rope: Adjustable up to 240 cm steel KACL.140

Wall – 66 cm
Island – 66 cm
Motor and Control
 450 m³/h
 3 spd + boost, touch control + leaf sensor
Anti-odour filters
 Carbon.Zeo filter 101078810
Lighting
 Led 4x1,2 W (3200 K)
Sound pressure level
Min. speed
 56 dB(A)re1pW
Max. speed
 63 dB(A)re1pW
Minimum distance from cooker top
 Gas hob: 60 cm
 Electric hob: 52 cm
Weight
 Wall version: 32 kg
 Island version: 29 kg

Wall – 66 cm
 White – 450 m³/h
8034122347936
Wall – 66 cm
 Black – 450 m³/h
8034122347943
Island – 66 cm
 White – 450 m³/h
8034122346991
Island – 66 cm
 Black – 450 m³/h
8034122347004

White glass/Black glass

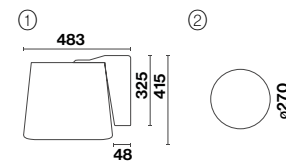
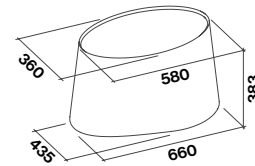

1 - Support for wall version.
 2 - Painted white ceiling support for island version, adjustable up to 110 cm steel wire rope included.



Life inspired.

Marilyn E.ion

- Handmade white ceramic
- Ionising system for air purification
- Perimeter suction with tempered glass panel
- Touch control + air quality indicator
- Automatic mode
- Led lighting
- Combined regenerable Carbon.Zeo filter
- Top filter, removable and washable

Optional accessories

Wire rope: Adjustable up to 240 cm steel KACL140

Wall – 67 cm
Island – 67 cm
Motor and Control
450 m³/h
3 spd + boost, touch control
+ leaf sensor
Anti-odour filters
Carbon.Zeo filter
101078810
Lighting
Led 4x1,2 W (3200 K)
Sound pressure level
Min. speed
56 dB(A)re1pW
Max. speed
63 dB(A)re1pW
Minimum distance from cooker top
Gas hob: 60 cm
Electric hob: 52 cm
Weight
Wall version: 36 kg
Island version: 33 kg

Wall – 67 cm
White – 450 m³/h
8034122347929

Island – 67 cm
White – 450 m³/h
8034122346977

E.ion System 

Ceramic

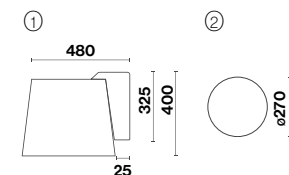
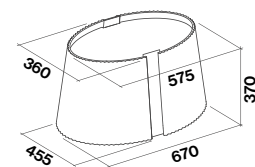

1 - Support for wall version.
2 - Painted white ceiling support for island version, adjustable up to 110 cm steel wire rope included.

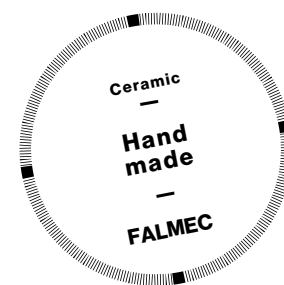

E.ion System
Marilyn E.ion





Design Studio Rigo

Twister E.ion

- Aluminium, titanium or black finish
- Ionising system for air purification
- Perimeter suction with tempered glass panel
- Touch control + air quality indicator
- Automatic mode
- Led lighting
- Combined regenerable Carbon.Zeo filter
- Top filter, removable and washable

Optional accessories

Wire rope: Adjustable up to 240 cm steel KACL.140

Island – 45 cm
Motor and Control
 450 m³/h
 3 spd + boost, touch control + leaf sensor
Anti-odour filters
 Carbon.Zeo filter
 101078810
Lighting
 Led 4x1,2 W (3200 K)
Sound pressure level
Min. speed
 56 dB(A)re1pW
Max. speed
 63 dB(A)re1pW
Minimum distance from cooker top
 Gas hob: 60 cm
 Electric hob: 52 cm
Weight
 23 kg

Island – 45 cm
 Titanium – 450 m³/h
8034122347066
Island – 45 cm
 Black – 450 m³/h
8034122349015

Titanium/Black

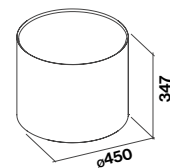

Painted white ceiling support, adjustable up to 110 cm steel wire rope included.





Lumière E.ion

- White tempered glass
- Ionising system for air purification
- Perimeter suction with tempered glass panel
- Touch control + air quality indicator
- Automatic mode
- Led lighting
- Combined regenerable Carbon.Zeo filter
- Top filter, removable and washable

Optional accessories

Wire rope: Adjustable up to 240 cm steel KACL.140

Island – 67 cm
Motor and Control
 450 m³/h
 3 spd + boost, touch control + leaf sensor
Anti-odour filters
 Carbon.Zeo filter
 101078810
Lighting
 Led 4x1,2 W (3200 K)
Sound pressure level
Min. speed
 56 dB(A)re1pW
Max. speed
 63 dB(A)re1pW
Minimum distance from cooker top
 Gas hob: 60 cm
 Electric hob: 52 cm
Weight
 32 kg

Island – 67 cm
 White – 450 m³/h
8034122346960

White tempered glass

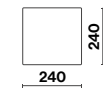
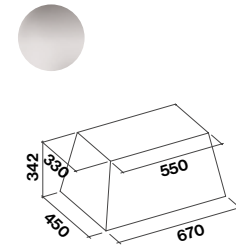

Painted white ceiling support, adjustable up to 110 cm steel wire rope included.

Eolo E.ion

- White or black glass
- Ionising system for air purification
- Perimeter suction with tempered glass panel
- Touch control + air quality indicator
- Automatic mode
- Led lighting
- Combined regenerable Carbon.Zeo filter
- Top filter, removable and washable

Optional accessories

Wire rope: Adjustable up to 240 cm steel KACL.140

Island – 45 cm
Motor and Control
 450 m³/h
 3 spd + boost, touch control + leaf sensor
Anti-odour filters
 Carbon.Zeo filter
 101078810
Lighting
 Led 4x1,2 W (3200 K)
Sound pressure level
Min. speed
 56 dB(A)re1pW
Max. speed
 63 dB(A)re1pW
Minimum distance from cooker top
 Gas hob: 60 cm
 Electric hob: 52 cm
Weight
 30 kg

Island – 45 cm
 White – 450 m³/h
8034122347011
Island – 45 cm
 Black – 450 m³/h
8034122347028

White glass/Black glass

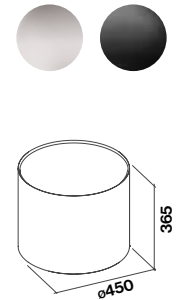

Painted white ceiling support, adjustable up to 110 cm steel wire rope included.



Spring E.ion

- White or black glass
- Ionising system for air purification
- Perimeter suction with tempered glass panel
- Touch control + air quality indicator
- Automatic mode
- Neon lighting
- Combined regenerable Carbon.Zeo filter
- Metallic grease filter, removable and washable

Optional accessories

Wire rope: Adjustable up to 240 cm steel KACL.140

Island – 80 cm
Motor and Control
 600 m³/h
 3 speed touch control + leaf sensor
Anti-odour filters
 Carbon.Zeo filter
 2x 101078811
Lighting
 Neon 3x13 W (6500 K)
Sound pressure level
Min. speed
 57 dB(A)re1pW
Max. speed
 64 dB(A)re1pW
Minimum distance from cooker top
 Gas hob: 60 cm
 Electric: 52 cm
Weight
 53 kg

Island – 80 cm
 White – 600 m³/h
8034122348568
Island – 80 cm
 Black – 600 m³/h
8034122348537

White glass/Black glass

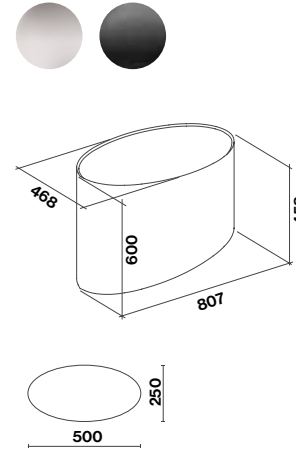

Painted white ceiling support, adjustable up to 110 cm steel wire rope included.

Gruppo Incasso E.ion

- Scotch Brite stainless steel (AISI 304)
- Ionising system for air purification
- Touch control + air quality indicator
- Automatic mode
- Led lighting
- Combined regenerable Carbon.Zeo filter
- Top filter, removable and washable

Built-in – 50/70 cm
Motor and Control
 450 m³/h
 3 spd + boost, touch control + leaf sensor
Anti-odour filters
 Carbon.Zeo filter
 101078810
Lighting
 Led 2x1,2 W (3200 K)
Sound pressure level
Min. speed
 56 dB(A)re1pW
Max. speed
 63 dB(A)re1pW
Minimum distance from cooker top
 Gas hob: 56 cm
 Electric hob: 52 cm
Weight
 50cm version: 24 kg
 70cm version: 26 kg

Built-in – 50 cm
 450 m³/h
8034122359342
Built-in – 70 cm
 450 m³/h
8034122359014

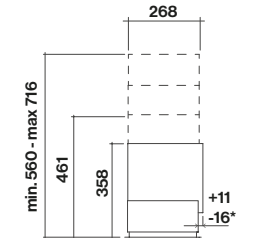
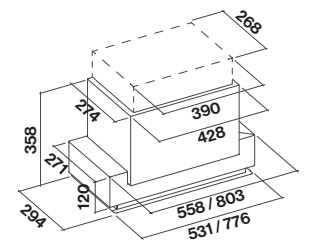

*Adjustable distance +11/-16mm

Cut-out size
 506 mm x 262 mm (50cm)
 751 mm x 262 mm (70cm)



Bellaria.

Bellaria changes the atmosphere of your home in every sense.

With the experience gained from the patented E.ion System, Falmecc has developed an innovative solution to purify the air in any domestic environment: Bellaria, unique in its successful performance, quietness and design.

Certified Efficiency.

Tests carried out by the University of Padua, Department of Molecular Medicine, have certified a drastic reduction of the bacterial charge in the environment and a concrete reduction of mycotic charge in the presence of Bellaria. The test results highlighted a bacterial charge reduction of 85% and mycotic charge reduction of 71% in the environment.

Enjoy pure air and a beautiful design, with unique technology.

Exclusive technology and beautiful aesthetics, Bellaria is made of handmade glass in line with the historical tradition of Venetian masters. A completely artisan production chosen by Falmecc in order to create a design product which unites the knowLedge and passion of the best Italian artisan tradition.

Pure Design.

Bellaria is available in four colours selected to be in harmony with all furnishing trends and tastes: in the living room, in the kitchen, in the workplace, wherever you want. Moreover, Bellaria has a dual function as it purifies the air and provides ambient light with an Led light adjustable in intensity.

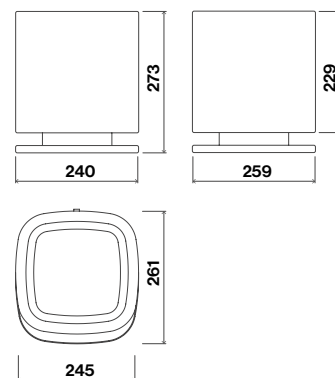
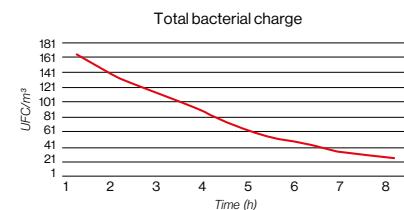
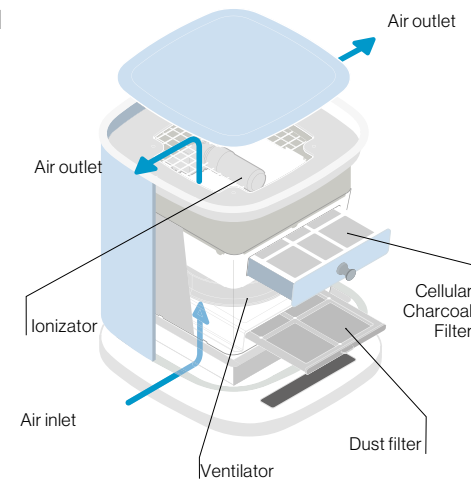

Learn more on: www.bellaria.falmecc.com

E.ion System
Bellaria



Design Marco Zito

White/Sand gray/Yellow/Red



White
8034122900117

Sand Gray
8034122900131

Yellow
8034122900124

Red
8034122900148





Silence — NRS.

Finally, a quiet hood.

Using innovative NRS technology, Falmecc has created a product that combines enhanced performance with noticeably improved home comfort. While there are figures that provide scientific proof of the excellent results achieved, the most important point is that the hood can barely be heard.

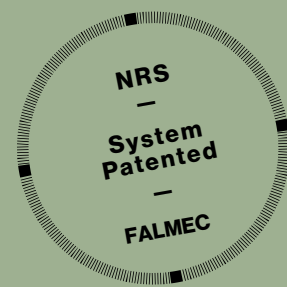

You won't just hear the difference - you'll live it.

NRS (Noise Reduction System) is the system developed by Falmecc in collaboration with laboratories specialising in fluid dynamics. It has enabled us to create a collection of incredibly quiet hoods, with considerable improvements in quality of life in the kitchen. NRS technology allows you to cook, work, chat and listen to music without the noise typically produced by hoods, while simultaneously maintaining excellent extraction performance.

Up to 86% reduction in sound levels.

Thanks to research into airflow and the specialist materials used, NRS hoods reduce noise to an extremely low, almost imperceptible level. The NRS system gives the best results in terms of the removal of cooking fumes, but can also be used in recirculation mode with a long-lasting, regenerable high-performance carbon filter.



Learn more about NRS System



Compared to standard extraction hoods on the market, noise is drastically reduced. Our perception of noise actually follows a logarithmic scale: for every reduction of 3 db, noise is halved.



Diagram of internal flows in an NRS hood. Soundproofing the motor chamber and research into airflows reduces operating noise to a minimum.

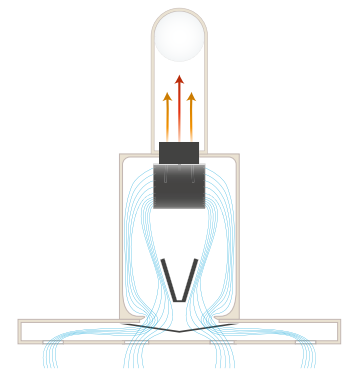

NRS

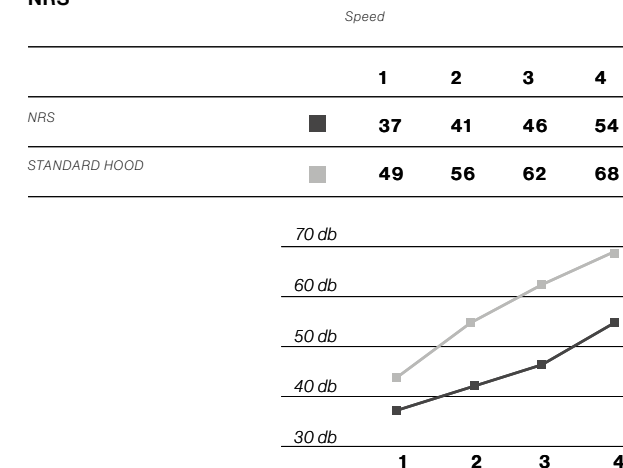

Speed

Perception of noise produced by a standard hood

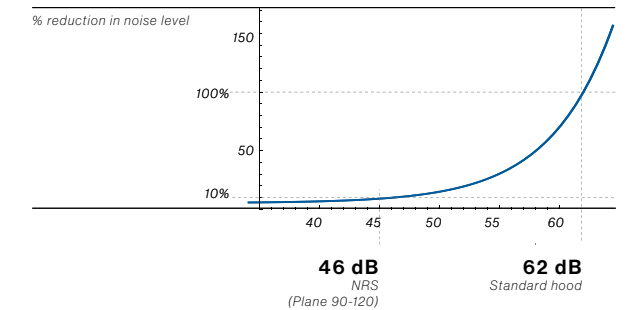



Lumina NRS

- Scotch Brite stainless steel (AISI 304)
- Tempered glass with steel, white or black finishing
- NRS technology for a quieter kitchen
- Touch control + 24h function
- Ambient light
- Metallic grease filter, removable and washable

Optional accessories

Anti-odour filters
Filter: Carbon.Zeo regenerable
KACL.961

Chimney extension: wall H700
KACL.570#I

Chimney extension: wall H960
KACL.571#I

Chimney extension: island H1200
KACL.572#I

Wall – 90/120 cm Motor and Control
800 m³/h
3 spd + boost, touch control
Anti-odour filters
Carbon.Zeo
KACL.961 (optional)
Lighting
Neon 90 cm: 1x21 W (6500 K)
Neon 120 cm: 1x28 W (6500 K)

Energy Class B
Sound pressure level
Min. speed
37 dB(A)re1pW
Max. speed
46 dB(A)re1pW
Minimum distance from cooker top
Gas hob: 65 cm/Electric hob: 52 cm
Weight
90 cm version: 36 kg
120 cm version: 41 kg

Wall – 90 cm
Steel – 800 m³/h
8034122344898
Wall – 90 cm
White – 800 m³/h
8034122348155
Wall – 90 cm
Black – 800 m³/h
8034122348162
Wall – 120 cm
Steel – 800 m³/h
8034122344881
Wall – 120 cm
White – 800 m³/h
8034122348131
Wall – 120 cm
Black – 800 m³/h
8034122348148

Island – 90 cm Motor and Control
800 m³/h
3 spd + boost, touch control
Anti-odour filters
Carbon.Zeo
KACL.961 (optional)
Lighting
Neon 2x21 W (6500 K)

Energy Class B
Sound pressure level
Min. speed
37 dB(A)re1pW
Max. speed
46 dB(A)re1pW
Minimum distance from cooker top
Gas hob: 65 cm
Electric hob: 52 cm
Weight
45 kg

Island – 90 cm
Steel – 800 m³/h
8034122344874
Island – 90 cm
White – 800 m³/h
8034122348117
Island – 90 cm
Black – 800 m³/h
8034122348124

White/Black/Stainless Steel

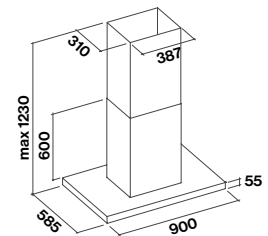
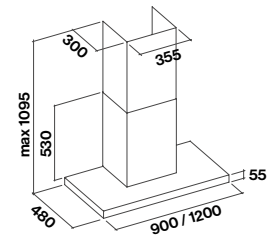

Lumen NRS **NEW**

- Scotch Brite stainless steel (AISI 304)
- NRS technology for a quieter kitchen
- Electronic control
- Led Lighting
- Ambient light
- Air Falmecc filter for balanced suction

Optional accessories

Anti-odour filters
Filter: Carbon.Zeo regenerable
KACL.961

Chimney extension: wall H700
KACL.570#I

Chimney extension: wall H960
KACL.571#I

Chimney extension: island H1200
KACL.572#I

Wall – 90 cm Island – 90 cm Motor and Control
800 m³/h
3 spd + boost, electronic control
Anti-odour filters
Carbon.Zeo
KACL.961 (optional)
Lighting
Led
Energy Class B

Sound pressure level
Min. speed
37 dB(A)re1pW
Max. speed
46 dB(A)re1pW
Minimum distance from cooker top
Electric hob: 52 cm
Gas hob: 63 cm
Weight
Wall version: 34 kg
Island version: 43 kg

Wall – 90 cm
800 m³/h
8034122362922

Island – 90 cm
800 m³/h
8034122362915

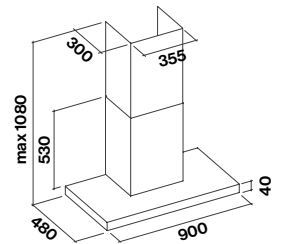
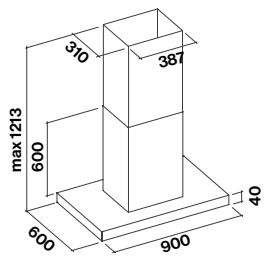

Available starting from January 2022



Lumen 175 NRS [NEW](#)

- Scotch Brite stainless steel (AISI 304)
- NRS technology for a quieter kitchen
- Perimeter suction
- Electronic control
- Led lighting on both sides
- Ambient light
- Metallic grease filter, removable and washable

Optional accessories

Anti-odour filters
Filter: Carbon.Zeo regenerable
 KACL.961

Chimney extension: island H1200
 KACL.572#1

Remote control
 105080053

Island – 175 cm
Motor and Control
 800 m³/h
 3 spd + boost, electronic control
Anti-odour filters
 Carbon.Zeo
 KACL.961 (optional)
Lighting
 Led 40 W (4000 K)
Energy Class
 B

Sound pressure level
Min. speed
 37 dB(A)re1pW
Max. speed
 46 dB(A)re1pW
Minimum distance from cooker top
 Gas hob: 60 cm
 Electric hob: 52 cm
Weight
 60 kg

Island – 175 cm
 Right version – 800 m³/h
8034122362892
Island – 175 cm
 Left version – 800 m³/h
8034122362908

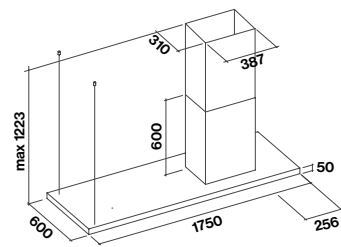

Right version

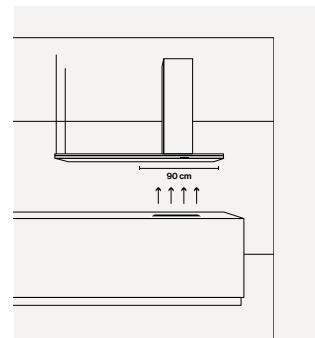

Suction surface is 90 cm wide, right below the chimney.

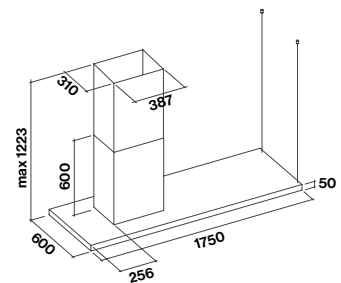

Left version





Plane Black NRS **NEW**

- Black painted steel
- NRS technology for a quieter kitchen
- Perimeter suction
- Electronic control
- Led lighting
- Metallic grease filter, removable and washable

Optional accessories

Anti-odour filters

Filter: Carbon.Zeo regenerable
KACL.961

Chimney extension: wall H960
KACL.571#N

Wall – 90 cm

Motor and Control

800 m³/h
3 spd + boost, electronic control

Anti-odour filters

Carbon.Zeo
KACL.961 (optional)

Lighting

Led 2 X 1W (3200 K)

Energy Class

B

Sound pressure level

Min. speed
37 dB(A)re1pW

Max. speed
46 dB(A)re1pW

Minimum distance from cooker top
Gas hob: 63 cm
Electric hob: 52 cm

Weight
34 kg

Wall – 90 cm

800 m³/h
8034122362816

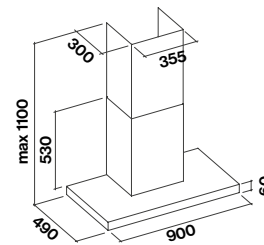

Plane NRS

- Scotch Brite stainless steel (AISI 304)
- NRS technology for a quieter kitchen
- Electronic control
- Led lighting
- Air Falmecc filter for balanced suction

Optional accessories

Anti-odour filters

Filter: Carbon.Zeo regenerable
KACL.961

Chimney extension: wall H700
KACL.570#I

Chimney extension: wall H960
KACL.571#I

Wall – 90/120 cm

Motor and Control

800 m³/h
3 spd + boost, electronic control

Anti-odour filters

Carbon.Zeo
KACL.961 (optional)

Lighting

Led
90 cm: 2x1,2 W (3200 K)
120 cm: 3x1,2 W (3200 K)

Energy Class

B

Sound pressure level

Min. speed
37 dB(A)re1pW

Max. speed
46 dB(A)re1pW

Minimum distance from cooker top
Gas hob: 63 cm
Electric hob: 52 cm

Weight
90 cm version: 34 kg
120 cm version: 36 kg

Wall – 90 cm
800 m³/h
8034122343235

Wall – 120 cm
800 m³/h
8034122343495

Island – 90/120 cm

Motor and Control

800 m³/h
3 spd + boost, electronic control

Anti-odour filters

Charcoal and Zeolite filter

Lighting

Led 4x1,2 W (3200 K)

Energy Class

B

Sound pressure level

Min. speed
37 dB(A)re1pW

Max. speed
46 dB(A)re1pW

Minimum distance from cooker top
Gas hob: 63 cm
Electric hob: 52 cm

Weight
90 cm version: 42 kg
120 cm version: 44 kg

Island – 90 cm
800 m³/h
8034122343228

Island – 120 cm
800 m³/h
8034122348384

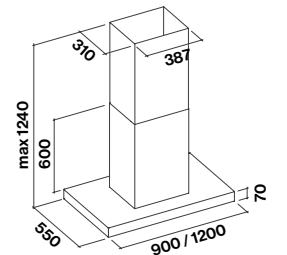
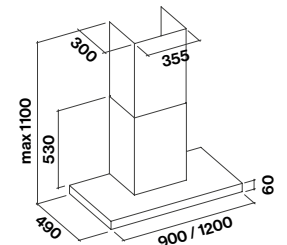



Verso NRS

- Tempered white or black glass
- NRS technology for a quieter kitchen
- Touch control + 24h function
- Dynamic Led Light
- Double suction area (frontal and lower)
- Frontal opening
- Metallic grease filter, removable and washable

Optional accessories

Anti-odour filters
Filter: High Performance Charcoal
KACL.959

Chimney 960 mm (white)
KACL.571#B
Chimney 960 mm (black)
KACL.571#N

Wall – 85 cm
Motor and control
800 m³/h
Control touch 3 spd + boost
Anti-odour filters
High Performance filter
KACL.959
Lighting
Dynamic Led Light
Led 2x1,2 W (2700-5600 K)
Energy Class
B
Sound pressure level
Min. speed
37 dB(A)re1pW
Max. speed
46 dB(A)re1pW
Minimum distance from cooker top
Gas hob: 57 cm
Electric hob: 52 cm
Weight
33 kg

Wall – 85 cm
Black - 800 m³/h
8034122360546
Wall – 85 cm
White - 800 m³/h
8034122360539

White/Black

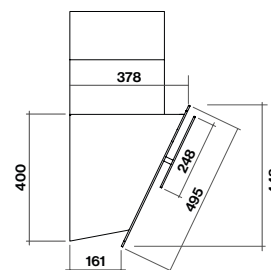
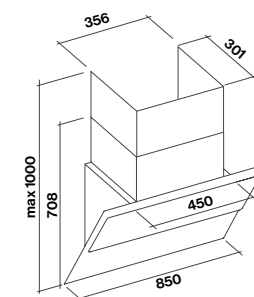

Lateral view



Flipper NRS

- White or black satin glass with stainless steel central band
- NRS technology for a quieter kitchen
- Electronic control
- Led lighting
- Metallic grease filter, removable and washable

Optional accessories

Anti-odour filters
Filter: High Performance Charcoal
2x 101078897

Chimney 960 mm (white)
KACL.571#B
Chimney 960 mm (black)
KACL.571#N

Wall – 85 cm
Motor and Control
800 m³/h
3 spd + boost, electronic control
Anti-odour filters
High Performance filter
2x 101078897
Lighting
Led 2x1,2 W (3200 K)
Energy Class
B
Sound pressure level
Min. speed
37 dB(A)re1pW
Max. speed
46 dB(A)re1pW
Minimum distance from cooker top
Gas hob: 52 cm
Electric hob: 52 cm
Weight
40 kg

Wall – 85 cm
Satin white 800 m³/h
8034122355115
Wall – 85 cm
Satin black 800 m³/h
8034122353739

Satin white glass/
Satin black glass

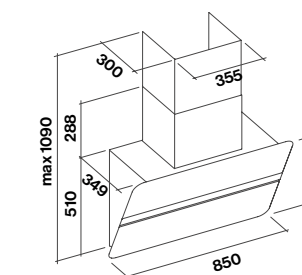

Life inspired.



Zenith NRS

- Scotch Brite (AISI 304) stainless steel
- Central stripe made in brilliant steel
- Tempered glass shelf
- NRS technology for a quieter kitchen
- Electronic control
- Led lighting
- Diffuse illumination on the shelf
- Metallic grease filter, removable and washable

Optional accessories

Anti-odour filters

Filter: Carbon.Zeo regenerable
KACL.961

Chimney extension: island H1200
KACL.572#1

Remote control
105080053

Island - 90/120/180 cm

Motor and Control

800 m³/h
3 spd + boost, electronic control

Anti-odour filters

Carbon.Zeo
KACL.961 (optional)

Lighting

Led stripe
Shelf 90 cm: 40 W (5500K)
Shelf 120 cm: 56 W (5500K)
Shelf 180 cm: 84 W (5500K)

Energy Class

C

Sound pressure level

Min. speed
37 dB(A)re1pW

Max. speed
46 dB(A)re1pW

Minimum distance from cooker top
Gas hob: 60 cm
Electric hob: 52 cm

Weight
90 cm version: 50 kg
120 cm version: 56 kg
Version 180 cm: 68 kg

Island - 90 cm*

800 m³/h

8034122354866 (Steel chassis)

KACL.127 (Glass kit)

Island - 120 cm*

800 m³/h

8034122354866 (Steel chassis)

KACL.128 (Glass kit)

Island - 180 cm*

800 m³/h

8034122354866 (Steel chassis)

KACL.129 (Glass kit)

*Hood is made by steel chassis and glass kit.

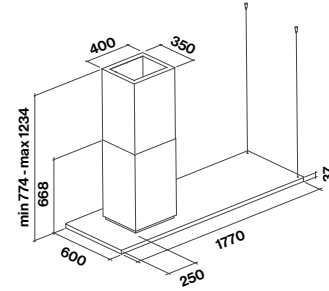
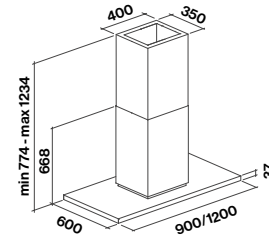

Silence NRS
Zenith NRS





Virgola NRS **NEW**

- Scotch Brite stainless steel
- NRS technology for a quieter kitchen
- Tempered turning glass flap
- Electronic control
- Dynamic Led Light
- Metallic grease filter, removable and washable

Optional accessories

Anti-odour filters
Filter: Carbon.Zeo regenerable
KACL.961

Telescopic chimney
315 + 295 mm
KCVJN.19#I

Remote control
105080053

Built-in – 60/90/120 cm
Motor and Control
800 m³/h
3 spd + boost, electronic control
Anti-odour filters
Carbon.Zeo
KACL.961 (optional)
Lighting
Led 1W (2700-5600K)
Energy Class
B
Sound pressure level
Min. speed
37 dB(A)re1pW
Max. speed
46 dB(A)re1pW
Minimum distance from cooker top
Gas hob: 57 cm
Electric hob: 52 cm
Poids net
60 cm version: 22 kg
90 cm version: 24,5 kg
120cm version: 27 kg

Built-in – 60 cm
Inox – 800 m³/h
8034122363660
Built-in – 90 cm
Inox – 800 m³/h
8034122363677
Built-in – 120 cm
Inox – 800 m³/h
8034122363653

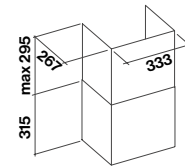
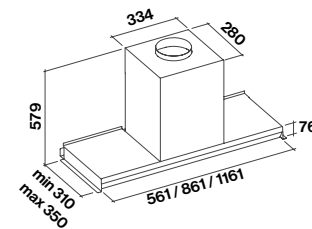

Optional chimney



Gruppo Incasso NRS

- Scotch Brite stainless steel (AISI 304)
- NRS technology for a quieter kitchen
- Electronic control
- Dynamic Led Light
- Metallic grease filter, removable and washable
- Remote control included

Optional accessories

Anti-odour filters
Filter: Carbon.Zeo regenerable
KACL.961

Built-in – 50/70 cm
Motor and Control
800 m³/h
3 spd + boost, electronic control
Anti-odour filters
Carbon.Zeo
KACL.961 (optional)
Lighting
Dynamic Led Light
2x1,2 W (2700-5600 K)
Energy Class
B
Sound pressure level
Min. speed
37 dB(A)re1pW
Max. speed
46 dB(A)re1pW
Minimum distance from cooker top
Gas hob: 57 cm
Electric hob: 52 cm
Weight
50 cm version: 22 kg
70 cm version: 23 kg

Built-in – 50 cm
800 m³/h
8034122343105
Built-in – 70 cm
800 m³/h
8034122343112

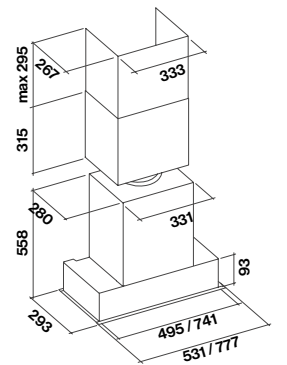

Cut-out size
50 cm: 506 mm x 262 mm
70 cm: 751 mm x 262 mm



No-Drop System.

No drips in the kitchen.

Falmec has developed innovative technology that finally solves the problem of liquids dripping due to cooking vapour condensation. This is an unpleasant and common occurrence, particularly accentuated when using induction hobs. No-Drop System consists of a set of filters with a criss-cross structure designed to channel liquids which are captured in a suitable container. Cooking vapours are instead spread and pulverized evenly across the filter surface, and then collected.

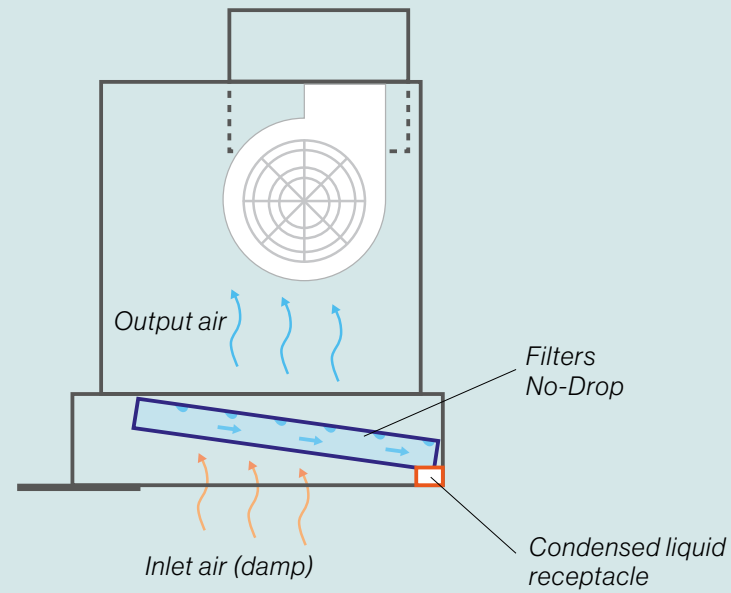

Gravity causes condensed vapours to slip along an inclined canal and flow into a receptacle for collecting liquids that can be emptied and replaced after cleaning.

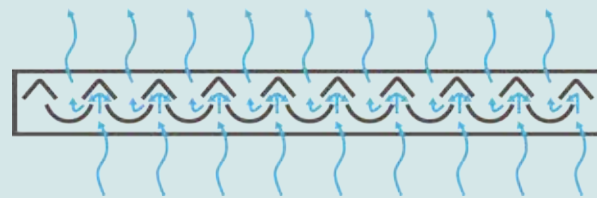

Profile of filter with criss-cross blades illustrating condensation of vapours.



Discover more about our No-Drop System technology

No-Drop System





Virgola No-Drop

- Stainless steel with Scotch Brite finish/black matt
- Rotating tempered glass flap (smoke on black matt version)
- Electronic control
- Dynamic Led Light
- Drainable and removable liquid collector and removable
- Anti-condensation system
- Rear outlet available

Optional accessories

- Glass Shelf 60 cm KACL.106
- Glass Shelf 90 cm KACL.107
- Glass Shelf 120 cm KACL.108

Steel Version

- Telescopic chimney 185+185 mm KCVJN.00#3
- Chimney 120 mm KCVJN.01#3

Black Matt Version

- Telescopic chimney 185+185 mm KCVJN.00#N
- Chimney 120 mm KCVJN.01#N

- Anti-odor filter Filter Carbon.Zeo KACL.961

- Remote motors List at p. 219

Built-in

- 60/75/90/120 cm
- Motor and Control 800 m³/h 3 spd + boost, electronic control
- Anti-odour filters Charcoal and Zeolite filter
- Lighting Dynamic Led Light 60/75/90 cm 2x1,2 W (2700-5600 K)
- 120 cm 4x1,2 W (2700-5600 K)

Energy Class

B

Sound pressure level

Min. speed 49 dB(A)re1pW

Max. speed 61 dB(A)re1pW

61 dB(A)re1pW

Minimum distance from cooker top

Gas hob: 52 cm

Electric hob: 52 cm

Weight

60 cm version: 11 kg

75 cm version: 12 kg

90 cm version: 16 kg

120 cm version: 17 kg

For best results from your hood and No-Drop technology, we recommend you use to the hood in extraction mode and check that it is correctly installed.

Steel Version

Built-in – 60 cm

Steel - 800 m³/h

8034122361406

Built-in – 75 cm

Steel - 800 m³/h

8034122361611

Built-in – 90 cm

Steel - 800 m³/h

8034122361420

Built-in – 120 cm

Steel - 800 m³/h

8034122361383

Black Matt Version

Built-in – 60 cm

Black - 800 m³/h

8034122361413

Built-in – 90 cm

Black - 800 m³/h

8034122361437

Built-in – 120 cm

Black - 800 m³/h

8034122361390

Steel/Black Matt

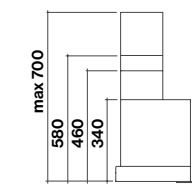
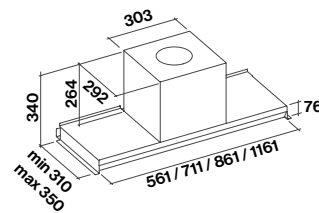

Side view with optional chimney

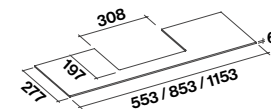

Gruppo Incasso No-Drop **NEW**

- Stainless steel (AISI 304) scotch brite finish
- Anti-condensation system
- 800 m³/h Motor
- Drainable and removable liquid collector and removable
- Electronic control
- Dynamic Led Light

Optional accessories

- Remote control 105080053

Anti-odour filters

- Filter: Charcoal Type 6 103050091

Remote motors

- List at p. 219

Built-in – 90 cm

Motor and Control

- 800 m³/h 3 spd + boost, electronic control

Anti-odour filters

- Charcoal filter: type 6

Lighting

- Dynamic Led Light 4 x 1,2 W (2700-5600 K)

Sound pressure level

Min. speed 49 dB(A)re1pW

Max. velocità 61 dB(A)re1pW

Minimum distance from cooker top

Gas hob: 62 cm

Electric hob: 52 cm

Weight

12 kg

Built-in – 90 cm

800 m³/h

8034122362281

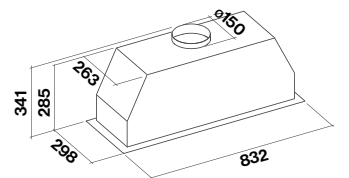

Cut-out size 807 x 267 mm



Plane No-Drop NEW

- Stainless steel (AISI 304) scotch brite finish
- Anti-condensation system
- Electronic control
- Drainable and removable liquid collector and removable
- Strip Led

Optional accessories

Anti-odour filters
Filter: Carbon.Zeo
KACL.961

Chimney extension: Wall h700
KACL.510#I

Chimney extension: Wall h960
KACL.512#I

Chimney extension: Island h1200
KACL.557#I

Remote motors
List at p. 219

Wall – 90 cm
Island – 90 cm
Motor and Control
800 m³/h
4 speed Electronic control
Anti-odour filters
Carbon.Zeo
KACL.961 (optional)
Lighting
Strip Led 3000 K
Energy class
B
Sound pressure level
Min. speed
49 dB(A)re1pW
Max. speed
62 dB(A)re1pW
Minimum distance from cooker top
Gas hob: 63 cm
Electric hob: 52 cm

Wall – 90 cm
Stainless steel
8034122362571

Island – 90 cm
Stainless steel
8034122362557

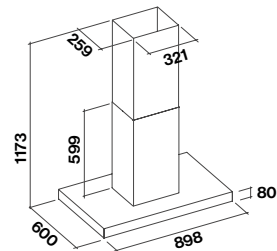
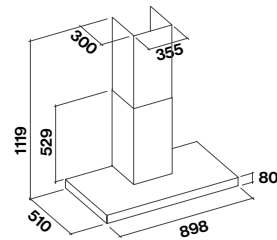



Design.

In search of the perfect hood.

A collection of hoods with a contemporary flavour to satisfy every desire and need in the kitchen. Featuring unique aesthetic and functional solutions, Design is a collection created from Falmec's creativity and different collaborations with established and emerging designers. An ongoing, shared "work in progress" that has allowed us to create a range inspired by absolute perfection: in its forms, its materials and its technologies.

Innovation designed for real people, made by real people.

Over the years, Falmec has concentrated all efforts on one type of cooker hoods. To try to improve them - and often succeeding, thanks to continuous research that has enabled us to refine the design and to offer the best product possible, without compromising on efficiency, ease of installation or performance. Discover how Falmec innovations can simplify and improve life.



Fasteel. Impossible to leave your fingerprints behind.

With Fasteel anti-fingerprint steel, your hood will always be shining and beautiful, thanks to innovative "No Finger-Print technology". This is a special finish that prevents the creation of streaks and fingerprints, making cleaning easier.



Dynamic Led Light. Shed new light on your kitchen.

The interior of your kitchen may have different sources of light which are not always in harmony in terms of tone. To even out the different colour temperatures of Led lights, Falmec has developed Dynamic Light, a new technology that electronically controls and regulates the colour temperature of your hood's lights, ranging from 2700K (warm light) to 5600K (cold light). This enables you to decide whether to set off your kitchen with warm or cold light, according to your personal preferences.

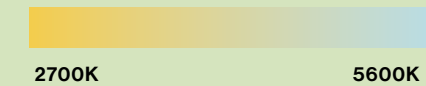

Green Tech.

Falmec, always thinking of the environment, presents Green Tech: a new technology that brings new levels of performance and energy saving to its products. Green Tech motors, equipped with an extraction capacity of 800m³/h, use electronic control that maximises the performance of the motor in every phase and mode of operation, contributing to a reduction in energy lost by the system. What's more, the use of permanent magnets placed on the motor allow a drastic reduction in the energy absorbed by the hood. In fact, compared to traditional motors, energy consumption is reduced by 60% in the fourth speed (maximum flow) and an impressive 90% in the first speed.





Design. Ceiling.

Falmec's ceiling hoods are designed to fit perfectly into any living environment. Thanks to their clean and minimal shapes and their discreet visual impact, they are suitable for open spaces where the kitchen area integrates with the living space.

These solutions collect the cooking fumes that rise naturally and are then captured directly in the ceiling. The hood can be integrated into a false ceiling or installed directly in the ceiling, in recirculating mode.





Design
Alba

Alba

- Glass perimeter frame
- Matte white customisable panel*
- Perimeter extraction
- Led perimeter lighting
- Removable and washable metallic filter
- Electronic button board
- Remote control included

**To customize the inner panel, we recommend sanding it with simple fine sandpaper (2200 or Scotch Brite) and apply acrylic washable paint.*

Optional accessories

Carbon.Zeo filtering kit ceiling
List at p. 223

Ceiling – 120 cm Motor

To match

Lighting

Led (4000 K)

Energy Class

with motor 950 m³/h: C

with motor 800 m³/h: C

Sound pressure level

Min. speed

50 dB(A)re1pW

Max. speed

64 dB(A)re1pW

Maximum distance

from cooker top

150 cm

Weight

45 kg

Available motors

KACL.798#41F

Motor 950 m³/h

8034122709833

KACL.782#49F

Slim motor 800 m³/h

8034122708584

KACL.770#41F

Motor brushless 1100 m³/h

8034122710211

KACL.797#4AF

Motor 1300 m³/h

8034122709628

KACL.786#41F

External extractor 1000 m³/h

8034122707433

KACL.796#4AF

External extractor 1500 m³/h

8034122709611

Ceiling

120 cm

8034122359526

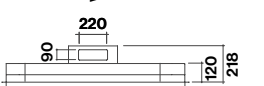
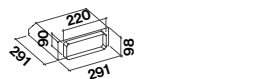
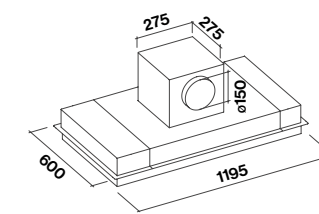

Junction (KACL.789)

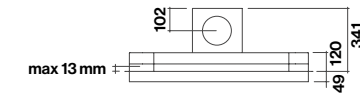

Onboard under-roof motor

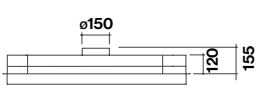

Remote motors

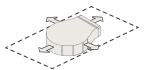
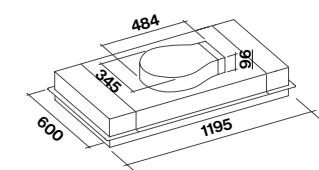

Slim motor outlets heading charts

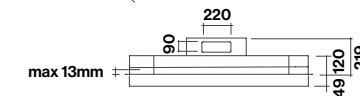

Slim motor (only onboard)

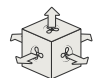

Under-roof motor/onboard motor outlets heading charts

Cut-out size
603 mm x 1200 mm

For further information regarding installation options and technical details, go to pp. 232-233.



Life inspired.



Skema NEW

- Brushed stainless steel (AISI 304) or painted black or white
- Tempered glass
- Perimeter suction
- Dynamic Led Light
- Electronic control
- Metallic grease filter, removable and washable
- Remote control included

Optional accessories

Carbon.Zeo filtering kit ceiling
List at p. 223

Ceiling – 120 cm
Motor and Control

To match

Lighting
Dynamic Led Light
43 W (2700-5600 K)

Energy class
B

Sound pressure level
Min. speed
50 dB(A)re1pW
Max. speed
64 dB(A)re1pW
Minimum distance from cooker top
150 cm
Weight
27 kg

Available motors

- KACL.798#41F**
Motor 950 m³/h
8034122709833
KACL.782#49F
Slim motor 800 m³/h
8034122708584
KACL.770#41F
Motor brushless 1100 m³/h
8034122710211
KACL.797#44F
Motor 1300 m³/h
8034122709628
KACL.786#41F
External extractor 1000 m³/h
8034122707433
KACL.796#44F
External extractor 1500 m³/h
8034122709611

- Ceiling – 120 cm**
White
8034122360966
Ceiling – 120 cm
Black
8034122360980
Ceiling – 120 cm
Stainless steel
8034122360973

White/Black/Stainless steel

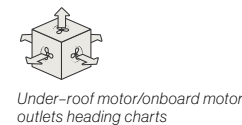
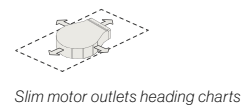
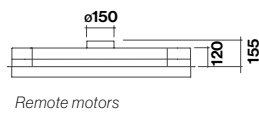
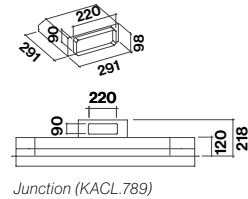
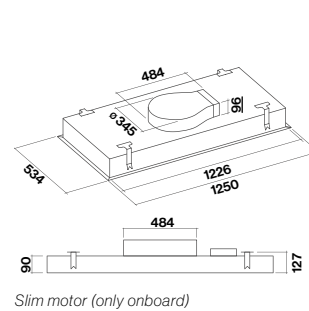
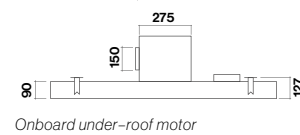
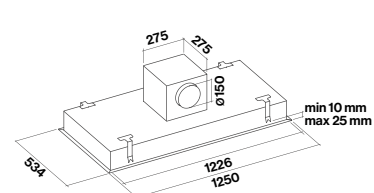

Under-roof motor/onboard motor outlets heading charts

For further information regarding installation options and technical details, go to pp. 232-233.

Design
Skema





Design
Nuvola Led 90



Nuvola Led 90 **NEW**

- Scotch Brite stainless steel (AISI 304) or white
- Tempered extra light painted glass
- Perimeter suction
- Anti-noise panel
- Electronic control
- Dynamic and Dimmable Led Light (diffused)
- Metallic grease filter, removable and washable
- Remote control included

Optional accessories

Carbon.Zeo filtering kit ceiling
List at p. 223

Ceiling – 90 cm Motor

To match
Lighting
Strip Led (2700-5500 K)
Energy Class
B

Sound pressure level

Min. speed
48 dB(A)_{re1pW}

Max. speed
62 dB(A)_{re1pW}

Maximum distance from cooker top

150 cm

Weight

24 kg

Available motors

- KACL.798#41F**
Motor 950 m³/h
8034122709833
- KACL.782#49F**
Slim motor 800 m³/h
8034122708584
- KACL.770#41F**
Motor brushless 1100 m³/h
8034122710211
- KACL.797#4AF**
Motor 1300 m³/h
8034122709628
- KACL.786#41F**
External extractor 1000 m³/h
8034122707433
- KACL.796#4AF**
External extractor 1500 m³/h
8034122709611

Ceiling – 90 cm Steel

8034122363127

Ceiling – 90 cm White

8034122363110

White/Stainless Steel

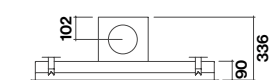
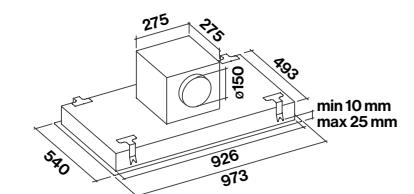

Onboard under-roof motor

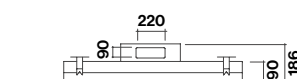
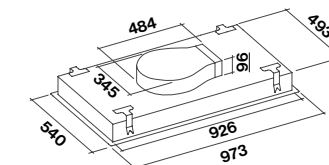

Slim motor (only onboard)

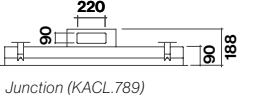
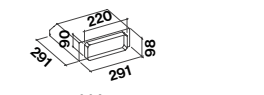

Junction (KACL.789)



Remote motors

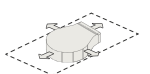

Slim motor outlets heading charts



Under-roof motor/onboard motor outlets heading charts

Cut-out size
505 mm x 940 mm

For further information regarding installation options and technical details, go to pp. 232-233.



DYNAMIC AND DIMMABLE LED LIGHT

Nuvola Led 140 **NEW**

- Scotch Brite stainless steel (AISI 304) or white
- Tempered extra light painted glass
- Perimeter suction
- Anti-noise panel
- Electronic control
- Dynamic and Dimmable Led Light (diffused)
- Metallic grease filter, removable and washable
- Remote control included

Optional accessories

Carbon.Zeo filtering kit ceiling
List at p. 223

Ceiling – 140 cm Motor

To match
Lighting
Strip Led (2700-5500 K)

Energy Class

with motor 950 m³/h: C
with motor 800 m³/h: D

Sound pressure level

Min. speed

48 dB(A)re1pW

Max. speed

62 dB(A)re1pW

Maximum distance from cooker top

150 cm

Weight

36 kg

Available motors

- KACL.798#41F**
Motor 950 m³/h
8034122709833
- KACL.782#49F**
Slim motor 800 m³/h
8034122708584
- KACL.770#41F**
Motor brushless 1100 m³/h
8034122710211
- KACL.797#4AF**
Motor 1300 m³/h
8034122709628
- KACL.786#41F**
External extractor 1000 m³/h
8034122707433
- KACL.796#4AF**
External extractor 1500 m³/h
8034122709611

Ceiling – 140 cm

Steel

8034122363189

Ceiling – 140 cm

White

8034122363172

White/Stainless Steel

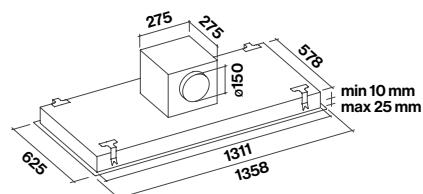

Onboard under-roof motor

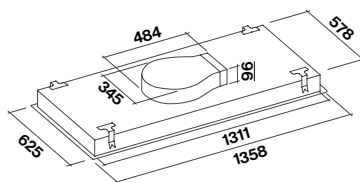

Slim motor (only onboard)

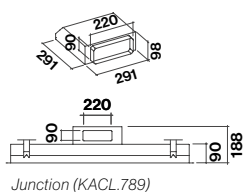

Junction (KACL.789)

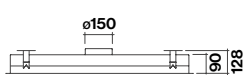

Remote motors

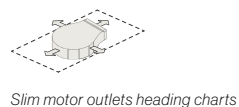

Slim motor outlets heading charts



Under-roof motor/onboard motor outlets heading charts

Cut-out size
590 mm x 1325 mm

For further information regarding installation options and technical details, go to pp. 232-233.



Nube

- Scotch Brite stainless steel (AISI 304)
- Perimeter suction
- Anti-noise panel
- Electronic control
- Metallic grease filter, removable and washable
- Remote control included

Optional accessories

Carbon.Zeo filtering kit ceiling
List at p. 223

Ceiling – 90 cm

Motor

To match

Energy Class

with motor 950 m³/h: A

with motor 800 m³/h: B

Sound pressure level

Min. speed

48 dB(A)re1pW

Max. speed

62 dB(A)re1pW

Maximum distance from cooker top

150 cm

Weight

21 kg

Available motors

- KACL.798#41F**
Motor 950 m³/h
8034122709833
- KACL.782#49F**
Slim motor 800 m³/h
8034122708584
- KACL.770#41F**
Motor brushless 1100 m³/h
8034122710211
- KACL.797#4AF**
Motor 1300 m³/h
8034122709628
- KACL.786#41F**
External extractor 1000 m³/h
8034122707433
- KACL.796#4AF**
External extractor 1500 m³/h
8034122709611

Ceiling – 90 cm

Steel

8034122363233

Ceiling – 90 cm

White

8034122363226

White/Stainless Steel

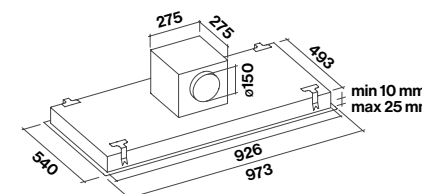

Onboard under-roof motor

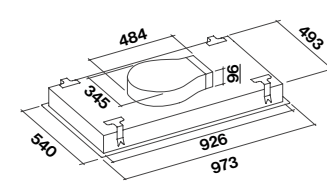

Slim motor (only onboard)

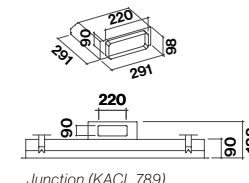

Junction (KACL.789)

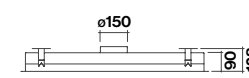

Remote motors



Slim motor outlets heading charts



Under-roof motor/onboard motor outlets heading charts

Cut-out size
505 mm x 940 mm

For further information regarding installation options and technical details, go to pp. 232-233.

Life inspired.



DYNAMIC AND DIMMABLE LED LIGHT

Stella

- Scotch Brite stainless steel (AISI 304) or painted black, white
- Perimeter suction
- Anti-noise panel
- Electronic control
- Dynamic and dimmable led light
- Metallic grease filter, removable and washable
- Remote control included

Optional accessories

Carbon.Zeo filtering kit ceiling
List at p. 223

Ceiling – 90/120 cm

Motor

To match

Lighting

Dynamic Led Light
Led 4x3,6 W (2700-5600 K)

Energy Class

with motor 950 m³/h: B
with motor 800 m³/h: B

Sound pressure level

Min. speed

48 dB(A)_{re1pW}

Max. speed

62 dB(A)_{re1pW}

Maximum distance from cooker top

150 cm

Weight

90 cm version: 22 kg
120 cm version: 26 kg

Available motors

KACL.798#41F

Motor 950 m³/h

8034122709833

Slim motor 800 m³/h

KACL.782#49F

Motor brushless 1100 m³/h

8034122708584

Motor brushless 1300 m³/h

KACL.770#41F

External extractor 1000 m³/h

8034122710211

Motor 1300 m³/h

KACL.797#4AF

External extractor 1500 m³/h

8034122709628

External extractor 1000 m³/h

KACL.796#4AF

External extractor 1500 m³/h

8034122709611

Ceiling – 90 cm

Steel

8034122363295

White

8034122363288

Black

8034122363301

Steel

8034122363271

White

8034122363264

White/Stainless Steel/Black

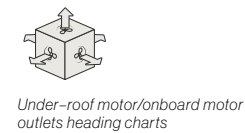
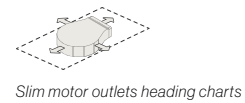
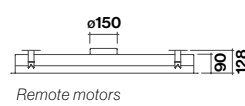
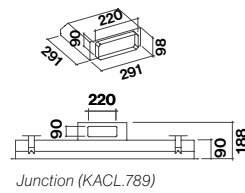
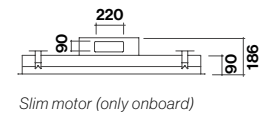
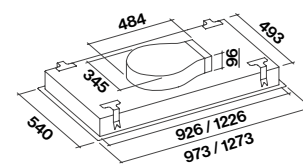
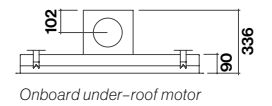
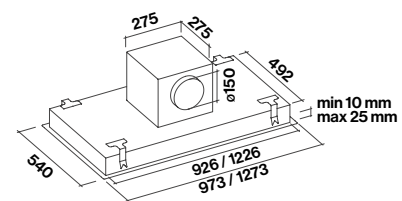

Cut-out size
90 cm: 505 mm x 940 mm
120 cm: 505 mm x 1240 mm

For further information regarding installation options and technical details, go to pp. 232-233.

Design
Stella



Life inspired.



Cielo

- Tempered extra-light white glass
- Perimeter suction
- Touch control
- Dynamic Led Light
- Metallic grease filter, removable and washable
- Combined regenerable Carbon.Zeo filter
- Remote control included

Ceiling – 120 cm
Motor and Control
600 m³/h
3 spd + boost, touch control
Anti-odour filters
Carbon.Zeo filter
Lighting
Dynamic Led Light
2x14 W (2700-5600 K)
Sound pressure level
Min. speed
53 dB(A)re1pW
Max. speed
61 dB(A)re1pW
Maximum distance from cooker top
150 cm
Weight
39 kg

Ceiling – 120 cm
600 m³/h
8034122348704

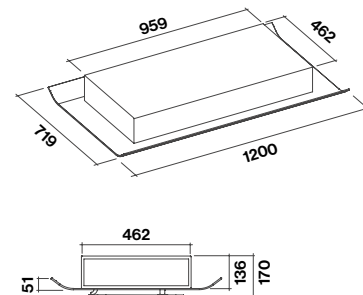

Design
Cielo





DYNAMIC AND DIMMABLE LED LIGHT

Aura

- Tempered extra-light white glass
- Perimeter suction
- Touch control
- Dynamic and dimmable led light
- Metallic grease filter, removable and washable
- Combined regenerable Carbon.Zeo filter
- Remote control included

Ceiling – 120 cm
Motor and Control
 600 m³/h
 3 spd + boost, touch control
Anti-odour filters
 Carbon.Zeo filter
Lighting
 Dynamic Led Light
 2x14 W (2700-5600 K)
Sound pressure level
Min. speed
 53 dB(A)re1pW
Max. speed
 61 dB(A)re1pW
Maximum distance from cooker top
 150 cm
Weight
 38 kg

Ceiling – 120 cm
 600 m³/h
 8034122354507

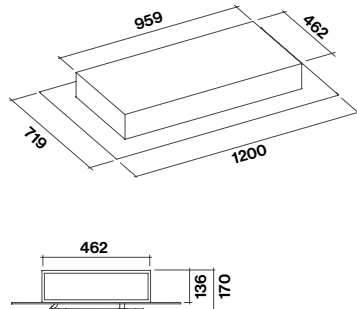

DYNAMIC AND DIMMABLE LED LIGHT

Sirio

- White tempered glass
- Perimeter suction
- Anti-noise panel
- Electronic control
- Metallic grease filter, removable and washable
- Dynamic and dimmable led light
- Remote control included

Optional accessories

Carbon.Zeo filtering kit ceiling
 List at p. 223

Ceiling – 90 cm
Motor
 To match
Lighting
 Dynamic Led Light
 Led 4x3,6 W (2700-5600 K)
Energy Class
 with motor 950 m³/h: B
 with motor 800 m³/h: B
Sound pressure level
Min. speed
 48 dB(A)re1pW
Max. speed
 62 dB(A)re1pW
Maximum distance from cooker top
 150 cm
Weight
 28 kg

Available motors

- KACL.798#41F**
 Motor 950 m³/h
 8034122709833
- KACL.782#49F**
 Slim motor 800 m³/h
 8034122708584
- KACL.770#41F**
 Motor brushless 1100 m³/h
 8034122710211
- KACL.797#4AF**
 Motor 1300 m³/h
 8034122709628
- KACL.786#41F**
 External extractor 1000 m³/h
 8034122707433
- KACL.796#4AF**
 External extractor 1500 m³/h
 8034122709611

Ceiling – 90 cm
 White glass
 8034122363240

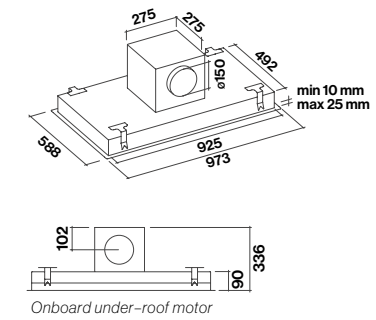

Onboard under-roof motor

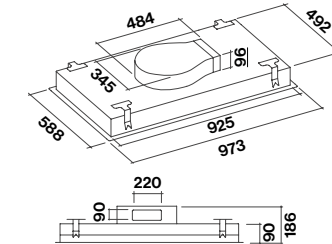

Slim motor (only onboard)

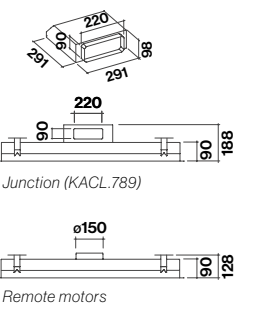

Junction (KACL.789)

Remote motors



Slim motor outlets heading charts

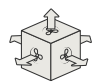

Under-roof motor/onboard motor outlets heading charts

Cut-out size
 505 mm x 940 mm

For further information regarding installation options and technical details, go to pp. 232-233.



Emo Design

Vega

- AISI 304 Stainless steel, painted white or black
- Tempered glass
- Circle.Tech technology with Carbon.Zeo filters
- Perimeter suction
- All-surface Led lighting
- Removable and washable metallic filter
- Dynamic and dimmable led light (diffused)
- Remote control included

Ceiling – 115 cm
Motor and Control
 600 m³/h
 3 spd + boost, electronic control
Anti-odour filters
 Carbon.Zeo filter
 KACL.944
Lighting
 Dynamic Led Light
 50 W (2700-5600 K)
Sound pressure level
Min. speed
 46 dB(A)_{re1pW}
Max. speed
 60 dB(A)_{re1pW}
Minimum distance from cooker top
 150 cm
Weight
 45 kg

Ceiling – 115 cm
 White – 600 m³/h
8034122477169
Ceiling – 115 cm
 Black – 600 m³/h
8034122477176
Ceiling – 115 cm
 Stainless Steel – 600 m³/h
8034122476940

White/Black/Stainless Steel

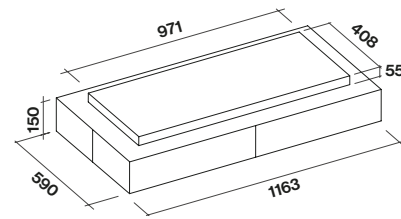



Design. Island/Suspended.

The kitchen is more and more of a convivial space, central to the home project, integrating with the living environment. An Island hood becomes a fundamental element from a functional and design point of view. It performs its function of suction and lighting, adding value and personality to the kitchen itself. Falmecc offers a wide choice of island hoods, with unique solutions, in ducted or recirculating versions, to always guarantee the best air.

Falmecc suspension hoods are distinguished by their unique design, featuring high-quality finishes and materials as well as ambient light to create a unique atmosphere in the kitchen. With no need for pipes or flues, suspension hoods allow complete freedom of installation and significant energy saving. Equipped with innovative filter technology, Falmecc's filter solutions guarantee excellent results when it comes to absorbing odours and improving air quality at home.





Circle.Tech Technology.

The new shape of filtration.

The circle represents perfection, the traditional symbol of something that has neither beginning nor end, formed of a single line whose ends join together and cancel each other out. Inspired by this form, Falmecc has developed a new line of hoods that combine extraction and filtration in a single element, allowing maximum efficiency and minimum impact on space.

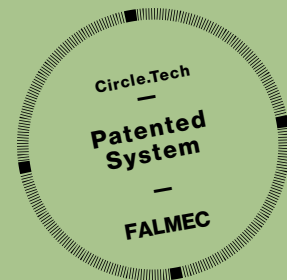

Technical sheet.

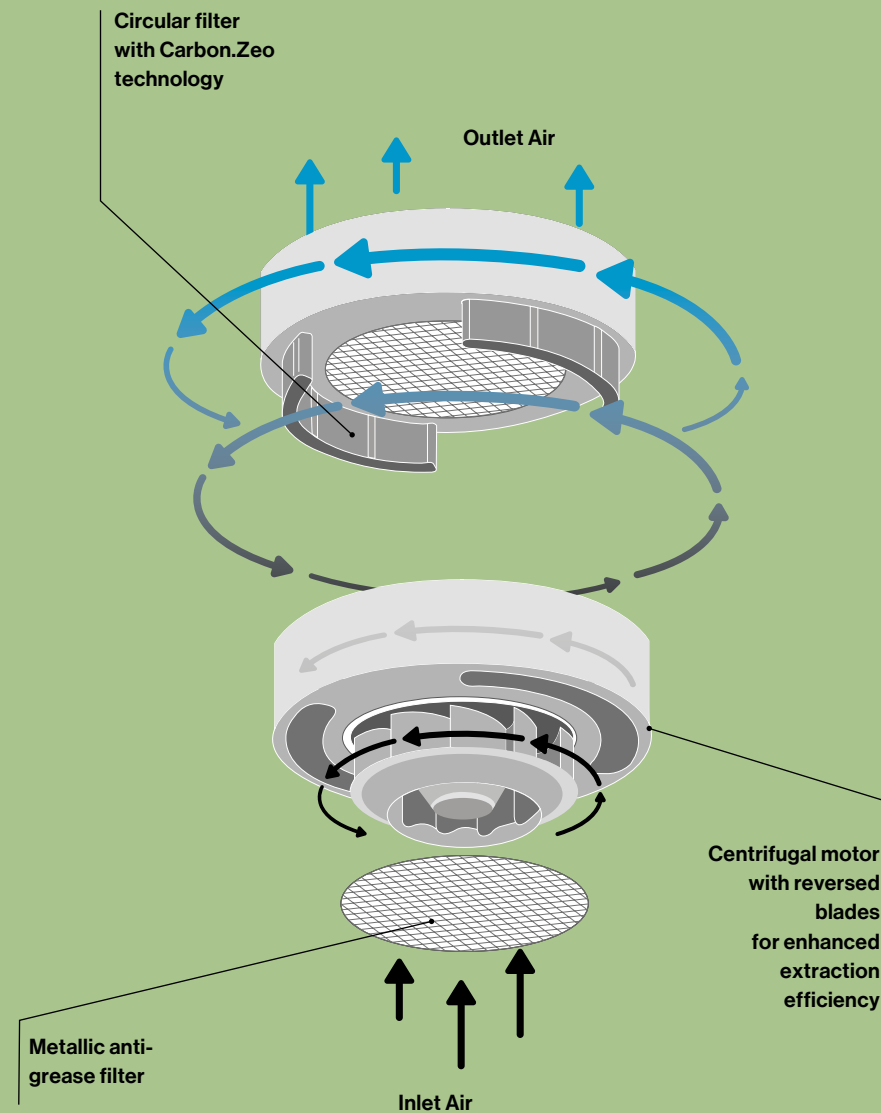

Learn more about our Circle.Tech technology.



Carbon.

Active carbons are materials made principally of carbon in the form of graphite microcrystals, specially treated to create a porous structure with a vast internal surface area. These characteristics make it capable of trapping the molecules of many different types of substance, attracting and absorbing them.

Zeolite.

Zeolite is a mineral with a high capacity for absorbing organic compounds and water vapour. This property is directly due to the microporous nature of its crystalline structure. In addition, the chemical characteristics of zeolite mean that it releases heat on contact with moisture, thus reducing it. The use of zeolite is therefore important both for reducing odours and for absorbing water vapour produced during cooking.



Long-lasting product, simple maintenance.

The Carbon.Zeo combined filter has a long life, lasting at least 3 years, and up to 5 years, under normal conditions of use. We recommend regenerating the filter every 18 months by placing it in an oven at 200°C for two hours. This process is extremely easy, with extraction performed in the lower part of the hood.

Life inspired.



As awarded by
The Chicago
Atheneum
Museum of
Architecture
and Design



Design Francesco Lucchese

Spazio

- Stainless (AISI 304) or black-painted steel chassis
- Circle.Tech technology with Carbon.Zeo filters
- Smoked glass shelves
- Dynamic and dimmable Led Light*
- Removable and washable metallic grease filter
- Equipped with power outlets and USB ports
- Ladle hanger, spice shelf, tablet holder included
- Indoor plants growing area (optional Falmece accessory)
- Remote control included

Optional accessories

Tissue holder (Black)

KACL.746#HF

Tissue holder (Steel)

KACL.746#IF

Kit 2 trays

KACL.744#IF

Light for plant growing area

KACL.745#IF

Extension Rods Kit Steel

KACL.748#IF

Extension Rods Kit Black

KACL.748#HF

Island – 180 cm

Motor and Control

600 m³/h

3 spd + boost, electronic control

Anti-odour filters

Carbon.Zeo

Lighting

4 x strip Led

(2700-5600 K)

Sound pressure level

Min. speed

46 dB(A)re1pW

Max. speed

60 dB(A)re1pW

Minimum distance from cooker top

Gas hob: 65 cm

Electric hob: 52 cm

Weight

68 kg

Island – 180 cm

Black – 600 m³/h

8034122476964

Island – 180 cm

Steel – 600 m³/h

8034122476957

Matte black/Steel

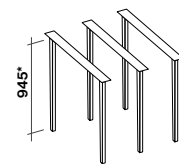
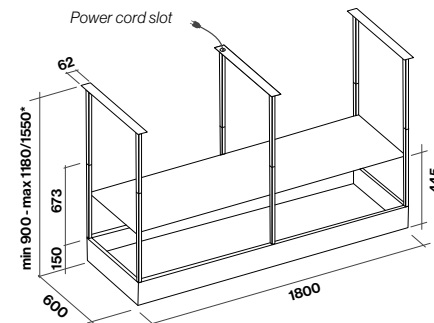

*Maximum height with rod extension: 1550 mm.

*Available starting from March 2022



Circle.Tech
Spazio



Life inspired.



Spazio 130 NEW

- Stainless (AISI 304) or black-painted steel chassis
- Smoked glass shelf
- Asymmetric and reversible extraction
- Circle.Tech technology with Carbon.Zeo filters
- Dynamic and dimmable Led Light*
- Removable and washable metallic grease filter
- Equipped with power outlets and USB ports
- Ladle hanger, spice shelf, tablet holder included
- Indoor plants growing area
- Remote control included

Optional accessories

Tissue holder (Black)
KACL.746#HF

Tissue holder (Inox)
KACL.746#IF

Kit 2 trays
for plant growing area
KACL.741#IF

Light for plant growing area
KACL.743#IF

Extension Rods Kit (Inox)
KACL.742#IF

Extension Rods Kit (Black)
KACL.742#HF

Island – 130 cm
Motor and Control
600 m³/h
3 spd + boost, electronic control
Anti-odour filters
Carbon.Zeo
KACL.944
Lighting
2 x strip led
(2700-5600 K)
Sound pressure level
Min. speed
46 dB(A)re1pW
Max. speed
60 dB(A)re1pW
Minimum distance from cooker top
Gas hob: 65 cm
Electric hob: 52 cm
Weight
51,7 kg

Island – 130 cm
Black matt – 600 m³/h
8034122477640

Island – 130 cm
Stainless steel – 600 m³/h
8034122477794

Black matt/stainless steel

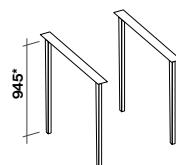
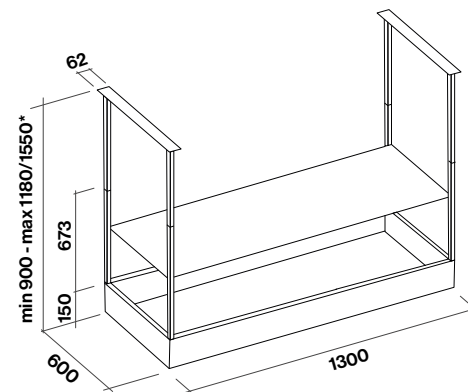

*Maximum height with optional trays kit: 1550 mm.

*Available starting from March 2022

Circle.Tech
Spazio 130





Spazio 180
Accessories

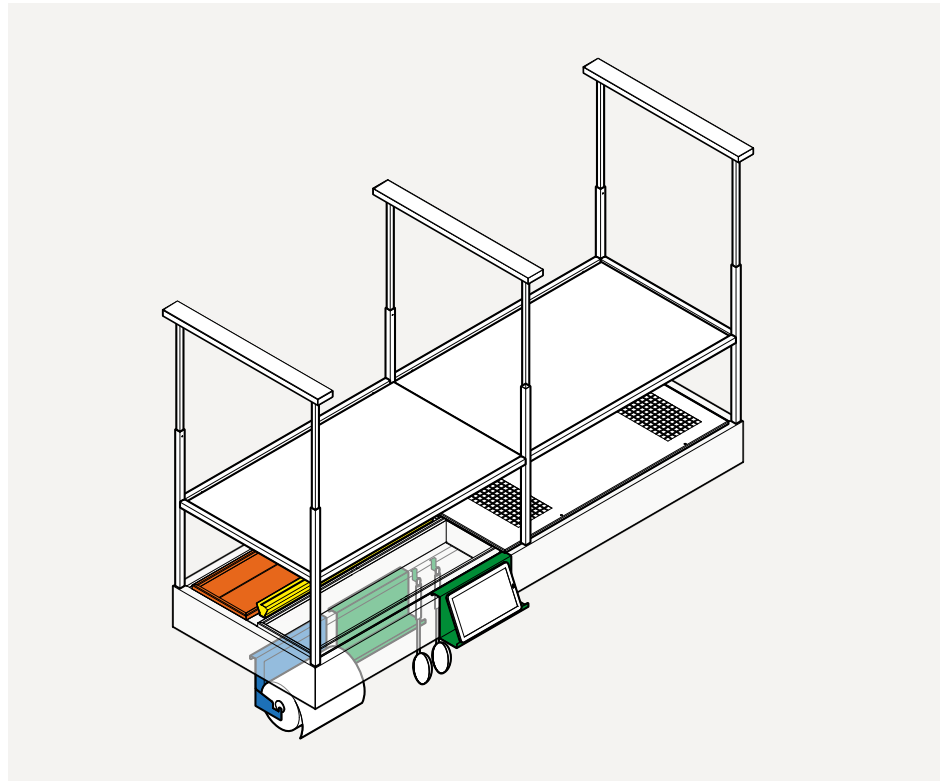

Spazio 130
Accessories

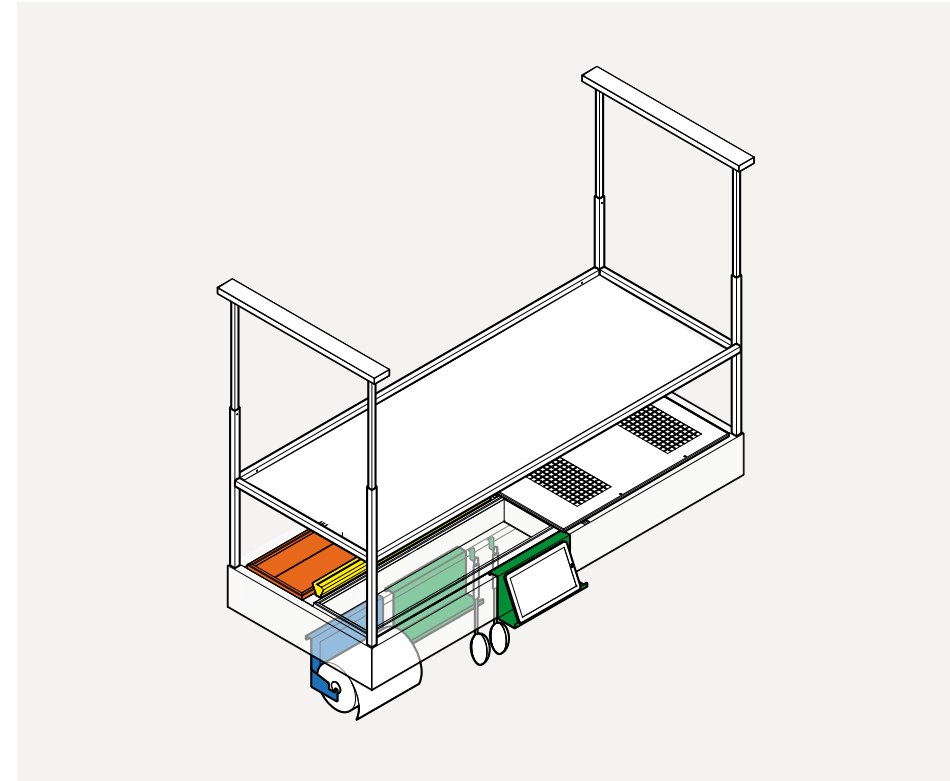

Included Accessories

- Tablet holder
- Spice holder
- Ladle holder hooks

Optional accessories

- KACL.746#HF
Tissue holder (Black)
- KACL.746#IF
Tissue holder (Steel)

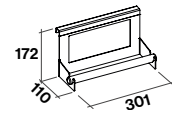

- KACL.744#IF
Kit 2 trays
for plant growing area

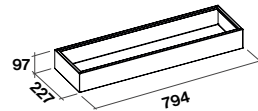

- KACL.745#IF
Light for plant
growing area

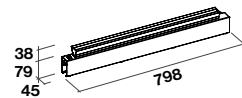

Design
Francesco Lucchese

Spazio is a system that amplifies the features of a suspended hood. Its versatility is a keypoint that we reached by increasing available room around the hood, allowing use on multiple levels, for a complete and dynamic experience. On the hanging support shelf the plants are a living presence for a real interaction with the "ingredients" necessary for good cooking. The activities on the work surface are facilitated by a hanging rail for all the accessories and by a large lighting surface. Choosing to create a suspended support of this type increases the capacity of the worktop, with a suspended kitchen area that multiplies its usability both on the horizontal and on the vertical plane, fully adapting to the work in the kitchen.

Included Accessories

- Tablet holder
- Spice holder
- Ladle holder hooks

Optional accessories

- KACL.746#HF
Tissue holder (Black)
- KACL.746#IF
Tissue holder (Steel)

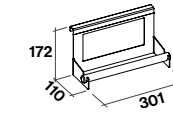

- KACL.741#IF
Kit 2 trays
for plant growing area

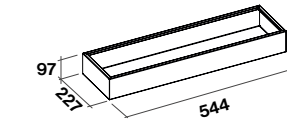

- KACL.743#IF
Light for plant
growing area

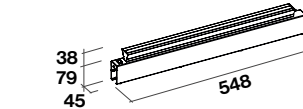



Circle.Tech
Dama



Emo Design

Dama

- Copper, Scotch Brite finish stainless steel or painted white, gunmetal
- Circle.Tech technology with Carbon.Zeo filters
- Rotary switch
- Perimeter suction with glass panel
- Led lighting
- Ambient Led lighting
- Removable and washable metallic filter

Optional accessories

Cables: adjustable up to 340 cm
KACL.143

Remote control
105080053

Island – 60 cm
Motor and Control
600 m³/h
3 spd + boost, rotary switch
Anti-odour filters
Carbon.Zeo filter
KACL.944
Lighting
Led 4x1,2 W (4200 K)
Ambient
14 W (4200 K)
Sound pressure level
Min. speed
46 dB(A)re1pW
Max. speed
60 dB(A)re1pW
Minimum distance from cooker top
Gas hob: 56 cm
Electric hob: 52 cm
Weight
21 kg

Island – 60 cm
White – 600 m³/h
8034122357997
Island – 60 cm
Gunmetal – 600 m³/h
8034122476704
Island – 60 cm
Steel – 600 m³/h
8034122476889
Island – 60 cm
Copper – 600 m³/h
8034122476728

White/Gunmetal/Stainless Steel/Copper



Painted white ceiling support,
adjustable cables range 44-110 cm

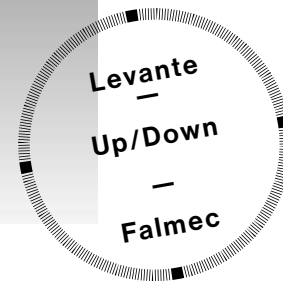

Levante

- White, black or graphite tempered glass and AISI 304 stainless steel frame with Scotch Brite finish
- Up/Down lift system with height adjustment
- Tempered glass
- Circle.Tech technology with Carbon.Zeo filters
- Perimeter extraction
- Removable and washable metallic filter
- Dynamic Led Light (diffused)
- Remote control included

Island (Up/Down) – 120 cm
Motor and Control
 600 m³/h
 3 spd + boost, electronic control
Anti-odour filters
 Carbon.Zeo filter
 KACL.944
Lighting
 Dynamic Led Light
 50 W (2700-5600 K)
Sound pressure level
Min. speed
 46 dB(A)re1pW
Max. speed
 60 dB(A)re1pW
Minimum distance from cooker top
 Gas hob: 57 cm
 Electric hob: 52 cm
Weight
 71 kg

White/Black/Graphite

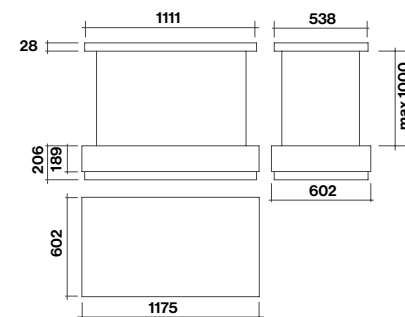

Island (Up/Down) – 120 cm
 White – 600 m³/h
8034122477183
Island (Up/Down) – 120 cm
 Black – 600 m³/h
8034122476933
Island (Up/Down) – 120 cm
 Graphite – 600 m³/h
8034122477664

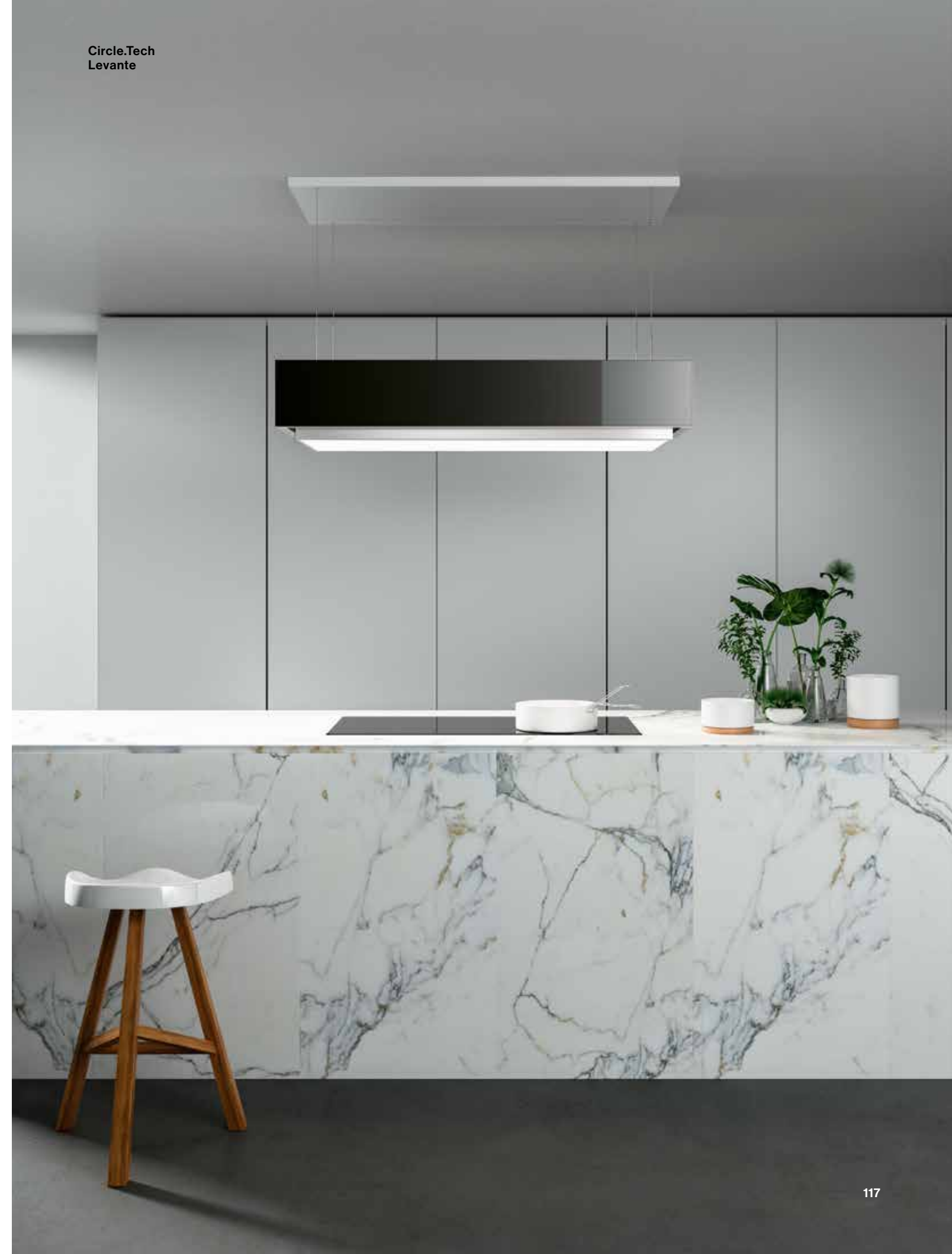

Life inspired.



Design Saggia-Sommella

Materia

- Single-shell concrete body
- Circle.Tech technology with Carbon.Zeo filters
- Electronic control
- Led lighting
- Removable and washable metallic filter
- Remote control included

Optional accessories

Cables: adjustable up to 340 cm
KACL.144

Island – 100 cm
Motor and Control
 600 m³/h
 3 spd + boost, electronic control
Anti-odour filters
 Carbon.Zeo filter
 KACL.944
Lighting
 Led 4x1,2 W (3200 K)
Sound pressure level
Min. speed
 46 dB(A)re1pW
Max. speed
 60 dB(A)re1pW
Minimum distance from cooker top
 Gas hob: 61 cm
 Electric hob: 52 cm
Weight
 30 kg

Island – 100 cm
 Concrete – 600 m³/h
8034122476841

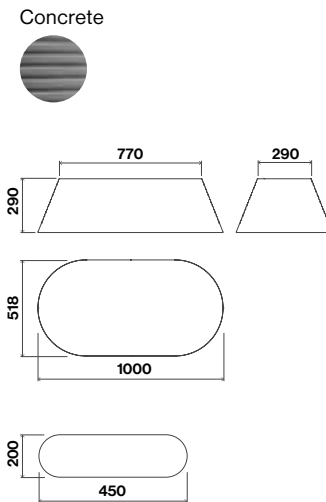

Painted white ceiling support, adjustable cables range 44-110 cm

The craftsmanship of the body of this hood makes the product a unique piece. Small imperfections and irregularities are not to be considered as flaws, but as proof of this hand-crafted manufacturing.

Circle.Tech
Materia





Circle.Tech
Soffio



Soffio

- Handmade blown glass
- Circle.Tech technology with Carbon.Zeo filters
- Rotary switch
- Perimeter suction with glass panel
- Led lighting
- Led ambient light
- Removable and washable metallic filter

Optional accessories

Cables: adjustable up to 340 cm
KACL.143

Remote control
105080053

Island – 58 cm
Motor and Control
600 m³/h
Rotary switch
3 spd + boost
Anti-odour filters
Carbon.Zeo filter
KACL.944
Lighting
Led 4x1,2 W (4200 K)
Ambient
15 W (4200 K)
Sound pressure level
Min. speed
46 dB(A)re1pW
Max. speed
60 dB(A)re1pW
Minimum distance from cooker top
Gas hob: 56 cm
Electric hob: 52 cm
Weight
21 kg

Island – 58 cm
White – 600 m³/h
8034122476735

Satin white glass

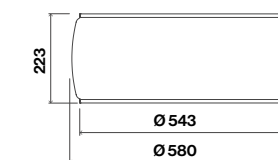

Painted white ceiling support,
adjustable cables range 44-110 cm



The craftsmanship of the body of this hood makes the product a unique piece. Small imperfections and irregularities are not to be considered as flaws, but as proof of this hand-crafted manufacturing.

Life inspired.



Emo Design

Circle.Tech
Loop



Loop

- Stainless steel AISI 304 or painted white and black gunmetal
- Circle.Tech technology with Carbon.Zeo filters
- Rotary switch
- Perimeter suction with glass panel
- Led lighting
- Led ambient light
- Removable and washable metallic filter

Optional accessories

Cables: adjustable up to 340 cm
KACL.143

Remote control
105080053

Island – 74 cm
Motor and Control
 600 m³/h
 Rotary switch
 3 spd + boost
Anti-odour filters
 Carbon.Zeo filter
 KACL.944
Lighting
 Led 4x1,2 W (4200 K)
 Ambient
 8 W (4200 K)
Sound pressure level
Min. speed
 46 dB(A)re1pW
Max. speed
 60 dB(A)re1pW
Minimum distance from cooker top
 Gas hob: 56 cm
 Electric hob: 52 cm
Weight
 29 kg

Island – 74 cm
 White – 600 m³/h
8034122358017
Island – 74 cm
 Gunmetal – 600 m³/h
8034122476858
Island – 74 cm
 Steel – 600 m³/h
8034122476896

White/Gunmetal/Steel

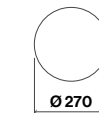
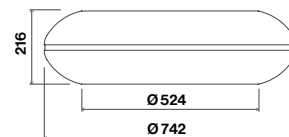

Painted white ceiling support,
adjustable cables range 44-110 cm

Life inspired.



Vetra

- AISI 304 Stainless steel, painted white
- Tempered glass
- Circle.Tech technology with Carbon.Zeo filters
- Perimeter suction
- All-surface Led lighting
- Removable and washable metallic filter
- Remote control included

Optional accessories

Cables: adjustable up to 340 cm
KACL.144

Island – 120 cm
Motor and Control
600 m³/h
3 spd + boost, electronic control
Anti-odour filters
Carbon.Zeo filter
KACL.944
Lighting
Led stripe
84 W (5500 K)
Sound pressure level
Min. speed
46 dB(A)re1pW
Max. speed
60 dB(A)re1pW
Minimum distance from cooker top
Gas hob: 57 cm
Electric hob: 52 cm
Weight
41 kg

Island – 120 cm
White – 600 m³/h
8034122476780
Island – 120 cm
Steel – 600 m³/h
8034122476797

Stainless Steel/White

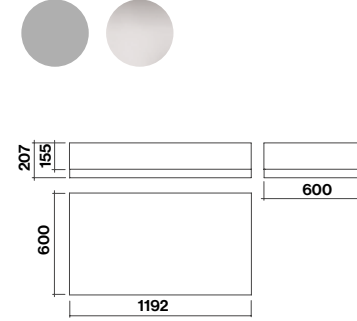

Circle.Tech
Vetra



Life inspired.



Sophie

- Painted steel
- Circle.Tech technology with Carbon.Zeo filters
- Rotary switch
- Perimeter suction with glass panel
- Led lighting
- Removable and washable metallic filter

Optional accessories

Cables: adjustable up to 340 cm
KACL.143

Remote control
105080053

Island – 54 cm Motor and Control

600 m³/h
Rotary switch
3 spd + boost

Anti-odour filters
Carbon.Zeo filter
KACL.944

Lighting

Led
18 W (4200 K)

Sound pressure level

Min. speed
47 dB(A)re1pW

Max. speed
60 dB(A)re1pW

Minimum distance from cooker top

Gas hob: 53 cm

Electric hob: 52 cm

Weight

21 kg

Island – 54 cm

White – 600 m³/h

8034122358031

Island – 54 cm

Anthracite – 600 m³/h

8034122358048

Island – 54 cm

Pewter – 600 m³/h

8034122476773

Island – 54 cm

Vintage Copper – 600 m³/h

8034122476872

Island – 54 cm

Vintage Brass – 600 m³/h

8034122476759

White/Anthracite/Pewter/
Vintage Brass/Vintage Copper

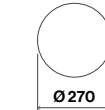
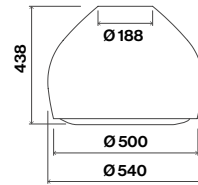
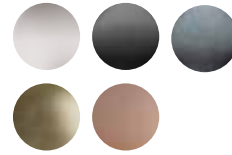

Painted white ceiling support,
adjustable cables range 44-110 cm

Circle.Tech
Sophie



Life inspired.



Sophie Lamp

- Painted stainless steel
- Led lighting (4200 K)

Island – 54 cm
White
8034122712178
Island – 54 cm
Anthracite
8034122712192
Island – 54 cm
Pewter
8034122712208
Island – 54 cm
Vintage Copper
8034122712161
Island – 54 cm
Vintage Brass
8034122712185

Island – 22 cm
White
8034122712123
Island – 22 cm
Anthracite
8034122712147
Island – 22 cm
Pewter
8034122712154
Island – 22 cm
Vintage Copper
8034122712116
Island – 22 cm
Vintage Brass
8034122712130

White/Anthracite/Pewter/
Vintage Brass/Vintage Copper

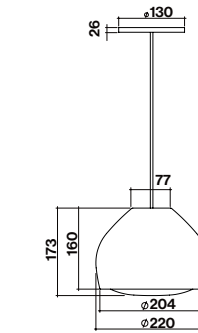
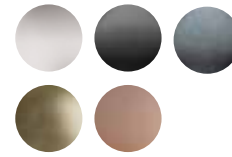

Version Ø22 cm

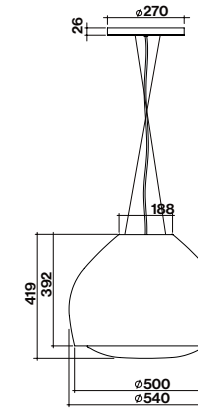

Version Ø54 cm*

Painted white ceiling support,
adjustable cables range 44-110 cm

Circle.Tech
Sophie Lamp



Multi-Air technology.

Multi-Air

Join the flat revolution.

Falmec's new Multi-Air technology revolutionizes the traditional concept of suction, concentrated in a single point.

The intuition is to divide the suction power into multiple ultra-compact motors, distributed horizontally, for a widespread suction, with extremely reduced height.

The advantages.

The advantages are multiples: reduced noise, homogeneous suction along the surface, effective filtration thanks to the Carbon.Zeo filter technology and, last but not least, ultra-compact design.

The flat Multi-Air system opens up new design horizons for new hood concepts, previously unthinkable: another revolution in the kitchen extraction world made by Falmec.

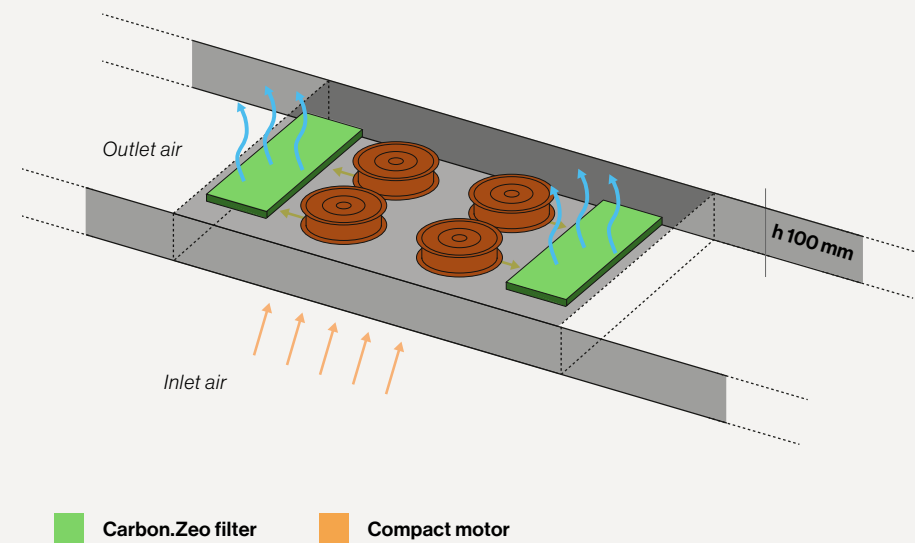

Life inspired.



Light **NEW**

- Painted steel
- Smoked tempered glass
- Black anodized satin aluminum profiles
- Perimeter suction
- Multi-Air technology
- Led lighting
- Ambient light
- Carbon.Zeo filter technology
- Electronic push-button panel
- Remote control included

Island – 120/180 cm
Motor and Control
 500 m³/h
 4 speed Electronic control
Anti-odour filters
 Carbon.Zeo
 KACL.964
Lighting
 Strip Led 3000 K
Sound pressure level
Min. speed
 35 dB(A)re1pW
Max. speed
 57 dB(A)re1pW
Minimum distance from cooker top
 Gas hob: 65 cm
 Electric hob: 52 cm
Weight
 120 cm version: 31 kg
 180 cm version: 40 kg

Island – 180 cm
 Aluminium black satin matt
8034122362885

Island – 120 cm
 Aluminium black satin matt
8034122362878

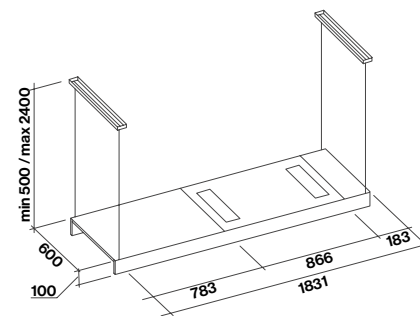

Light 180

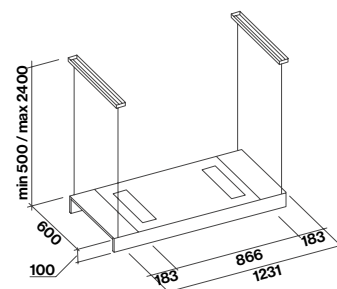

Light 120

Design
Light



Life inspired.



Elle **NEW**

- Matt black painted steel
- Strip Led
- Electronic control
- Perimeter suction
- Dynamic and dimmerable led light
- Metallic grease filter, removable and washable

Optional accessories

Anti-odour filters
Filter: Carbon.Zeo
KACL.961

Chimney extension:
Island h1200
KACL.557#N

Remote control
105080053

Island - 175 cm
Motor and Control
800 m³/h
4 speed Electronic control
Anti-odour filters
Carbon.Zeo
KACL.961 (optional)
Lighting
4 x strip led
(2700-5600 K)
Energy class
C
Sound pressure level
Min. speed
49 dB(A)re1pW
Max. speed
61 dB(A)re1pW
Minimum distance from cooker top
Gas hob: 63 cm
Electric hob: 52 cm

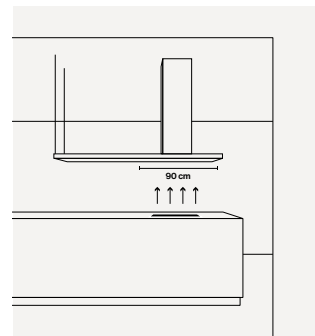

The suction surface measures 90 cm and is in correspondence with the chimney of the hood.

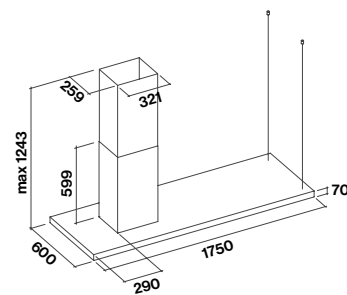

Island - 175 cm
Black
8034122362533

Design
Elle



Life inspired.



Lumen Island 175

- Scotch Brite stainless steel (AISI 304)
- Perimeter suction
- Electronic control
- Led lighting on both sides
- Metallic grease filter, removable and washable
- Charcoal filter included

Optional accessories

Anti-odour filters
 Filter: Carbon.Zeo
 KACL.961

Chimney extension: Island h1200
 KACL.557#1

Remote motors
 List at p. 219

Island – 175 cm
Motor and Control
 800 m³/h
 3 spd + boost, electronic control
Anti-odour filters
 Carbon.Zeo
 KACL.961 (optional)
Lighting
 Led stripe 40 W (4000 K)
Energy Class
 C
Sound pressure level
Min. speed
 49 dB(A)re1pW
Max. speed
 62 dB(A)re1pW
Minimum distance from cooker top
 Gas hob: 63 cm
 Electric hob: 52 cm
Weight
 48 kg

Island – 175 cm
 Right hand version – 800 m³/h
8034122363752
Island – 175 cm
 Left hand version – 800 m³/h
8034122363769

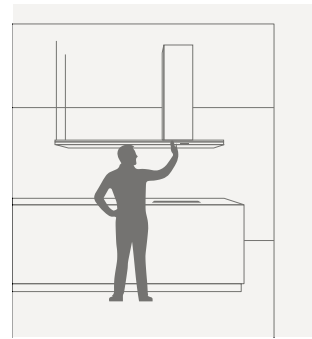

Right hand side example: chimney and button boards are on the right side when standing in front of the hood.

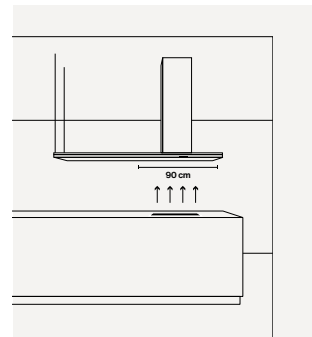

Suction surface is 90 cm wide, right below the chimney.

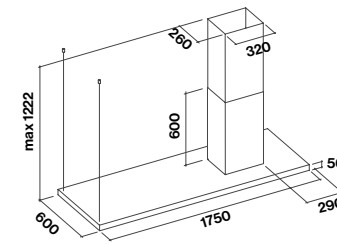

Right hand side version

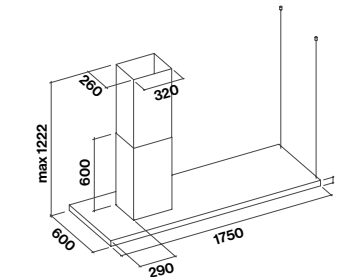

Left hand side version

Design
Lumen Island 175





Europa

- Scotch Brite stainless steel (AISI 304)
- Perimeter suction
- Electronic control
- Led lighting
- Metallic grease filter, removable and washable
- Charcoal filter included

Optional accessories

- Shelf glass** 90 cm
KACL.064
- Island glass** 90 cm
KACL.066
- Island glass** 120 cm
KACL.065

- Remote motors**
List at p. 219

**Island – 90/120 cm
Motor and Control**
800 m³/h
3 spd + boost, electronic control

Anti-odour filters
Charcoal: type 3

Lighting
Led 4x1,2 W (3200 K)

Lighting mensola
Led 4x1,2 W (3200 K)

Energy Class
B

Sound pressure level

Min. speed
49 dB(A)re1pW

Max. speed
61 dB(A)re1pW

Minimum distance from cooker top
Gas hob: 63 cm
Electric hob: 52 cm

Weight
90 cm version: 35 kg
90 cm glass: 8 kg
120 cm version: 41 kg
120 cm glass: 10 kg
90 cm shelf: 15 kg
90 cm glass shelf: 8 kg

Island – 90 cm
800 m³/h
8034122205984

Island – 120 cm
800 m³/h
8034122205977

Shelf – 90 cm
Glass
8034122205991

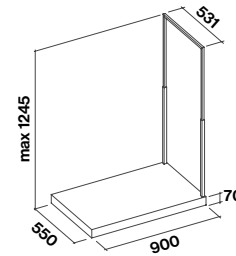
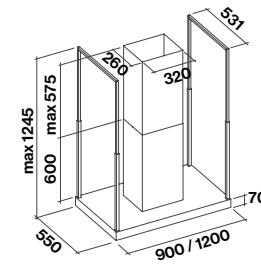



Design. Wall/Island.

The wall hood is traditionally the most used option, perfect for optimal fume extraction, if chosen and installed correctly. The wall hood combines functionality and design, often representing a decorative element of separation and customisation of the kitchen.

Falmec's ceiling hoods are designed to fit perfectly into any living environment. Thanks to their clean and minimal shapes and their discreet visual impact, they are suitable for open spaces where the kitchen area integrates with the living space.

These solutions collect the cooking fumes that rise naturally and are then captured directly in the ceiling. The hood can be integrated into a false ceiling or installed directly in the ceiling, in recirculating mode.





Lumen

- Scotch Brite stainless steel (AISI 304)
- Electronic control
- Led Lighting
- Ambient Light
- Air Falmecc filter for balanced suction
- Charcoal filter included

Optional accessories

Chimney extension: Wall h700
KACL.510#I

Chimney extension: Wall h960
KACL.512#I

Chimney extension: Island h1200
KACL.557#I

Remote motors
List at p. 219

Carbon.Zeo filtering kit
List at p. 224

Island – 90/120 cm
Motor and Control
800 m³/h
3 spd + boost, electronic control
Anti-odour filters
Charcoal: type 3
Lighting
Led 5700 K
Energy Class
C

Sound pressure level
Min. speed
49 dB(A)re1pW
Max. speed
62 dB(A)re1pW
Minimum distance from cooker top
Gas hob: 63 cm
Electric hob: 52 cm
Weight

90 cm version: 31 kg
120 cm version: 35 kg

Island – 90 cm
800 m³/h
8034122323336
Island – 120 cm
800 m³/h
8034122322872

Wall – 60/90/120 cm
Motor and Control
600 m³/h
Electronic control 3 speed
800 m³/h
3 spd + boost, electronic control
Anti-odour filters
Charcoal: type 3
Lighting
Led 5700 K
Energy Class
C

Sound pressure level
Min. speed
90 cm - 600 m³/h: C
60/90 cm - 800 m³/h: B
120 cm - 800 m³/h: C
Sound pressure level/Min. speed
49 dB(A)re1pW
Max. speed
62 dB(A)re1pW
Minimum distance from cooker top
Gas hob: 63 cm
Electric hob: 52 cm
Weight

60 cm version: 17 kg
90 cm version: 19 kg
120 cm version: 23 kg

Wall – 60 cm
800 m³/h
8034122324289
Wall – 90 cm
800 m³/h
8034122324876
Wall – 120 cm
800 m³/h
8034122323824

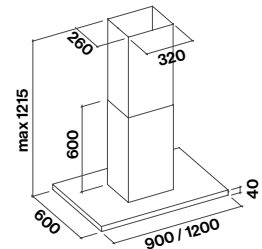
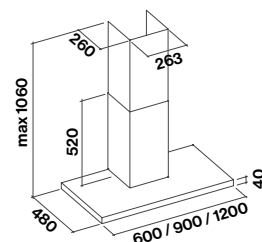

Plane Black/White

- Painted white or black matte steel
- Perimeter suction
- Electronic control
- Led lighting
- Metallic grease filter, removable and washable
- Charcoal filter included

Optional accessories

Remote motors
List at p. 219

Chimney extension: Island h1200
KACL.557#N (black)

Chimney extension: Island h1200
KACL.557#B (white)

Chimney extension: Wall h960
KACL.512#N (black)

Chimney extension: Wall h960
KACL.512#B (white)

Wall – 90 cm
Motor and Control
800 m³/h
3 spd + boost, electronic control
Anti-odour filters
Charcoal: type 3
Lighting
Led 2x1,2 W (3200 K)
Energy Class
B

Sound pressure level
Min. speed
49 dB(A)re1pW
Max. speed
62 dB(A)re1pW
Minimum distance from cooker top
Gas hob: 63 cm
Electric hob: 52 cm
Weight
20 kg

Wall – 90 cm
White – 800 m³/h
8034122342108
Wall – 90 cm
Black – 800 m³/h
8034122359892

Island – 90 cm
Motor and Control
800 m³/h
3 spd + boost, electronic control
Anti-odour filters
Charcoal: type 3
Lighting
Led 4x1,2 W (3200 K)
Energy Class
B

Sound pressure level
Min. speed
49 dB(A)re1pW
Max. speed
61 dB(A)re1pW
Minimum distance from cooker top
Gas hob: 63 cm
Electric hob: 52 cm
Weight
31 kg

Island – 90 cm
White – 800 m³/h
8034122342092
Island – 90 cm
Black – 800 m³/h
8034122359885

Black/White

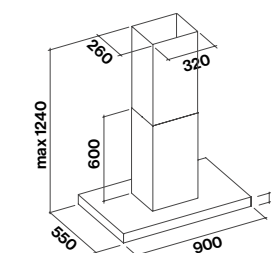
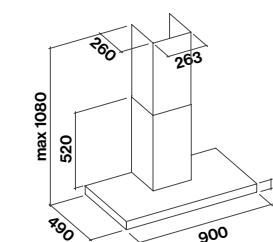



Plane

- Scotch Brite stainless steel (AISI 304)
- Electronic control
- Led lighting
- Air Falmec filter for balanced suction
- Charcoal filter included

Optional accessories

- Chimney extension:** Wall h700 KACL.510#I
- Chimney extension:** Wall h960 KACL.512#I
- Chimney extension:** Island h1200 KACL.557#I

- Remote motors**
List at p. 219

Wall – 90/120 cm
Island – 90/120 cm
Motor and Control
 3 spd + boost, electronic control
Anti-odour filters
 Charcoal: type 3
Lighting
 Wall: 90 cm
 Led 2x1,2 W (3200 K)
 Wall: 120 cm
 Led 3x1,2 W (3200 K)
 Island: 90/120 cm
 Led 4x1,2 W (3200 K)
Energy Class
 B
Sound pressure level
Min. speed
 49 dB(A)re1pW
Max. speed
 62 dB(A)re1pW
Minimum distance from cooker top
 Gas hob: 63 cm
 Electric hob: 52 cm
Weight
 90 cm Wall version: 18 kg
 120 cm Wall version: 22 kg
 90 cm Island version: 30 kg
 120 cm Island version: 32 kg

Wall – 90 cm
 800 m³/h
8034122331058
Wall – 120 cm
 800 m³/h
8034122330273

Island – 90 cm
 800 m³/h
8034122329802
Island – 120 cm
 800 m³/h
8034122329406

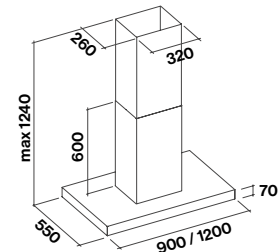
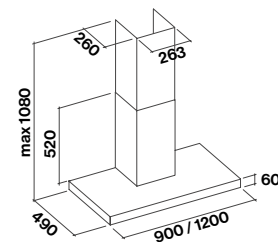

Plane Green Tech

- Scotch Brite stainless steel (AISI 304)
- New Green Tech motor
- Dynamic Led Light
- Air Falmec filter for balanced suction
- Charcoal filter included

Optional accessories

- Chimney extension:** Wall h700 KACL.510#I
- Chimney extension:** Wall h960 KACL.512#I
- Chimney extension:** Island h1200 KACL.557#I

- Remote motors**
List at p. 219

- Carbon.Zeo** filtering kit
List at p. 224

Wall – 90 cm
Island – 90 cm
Motor and Control
 800 m³/h Green Tech
 3 spd + boost, electronic control
Anti-odour filters
 Charcoal: type 3
Lighting
 Dynamic Led Light
 Wall: 90 cm
 2x1,2 W (2700-5600 K)
 Island: 90 cm
 4x1,2 W (2700-5600 K)
Energy Class
 A+
Sound pressure level
Min. speed
 48 dB(A)re1pW
Max. speed
 62 dB(A)re1pW
Minimum distance from cooker top
 Gas hob: 63 cm
 Electric hob: 52 cm
Weight
 Wall version: 18 kg
 Island version: 30 kg

Wall – 90 cm
 800 m³/h
8034122101798

Island – 90 cm
 800 m³/h
8034122101781

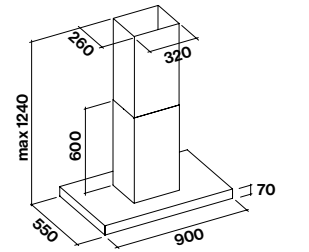
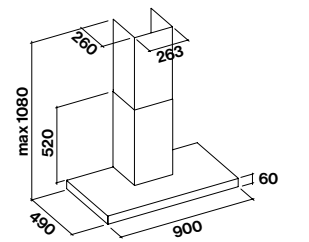



Plane Top (Fasteel)

- Scotch Brite Fasteel no finger prints
- Perimeter suction
- Electronic control
- Dynamic Led Light
- Metallic grease filter, removable and washable
- Charcoal filter included

Optional accessories

Chimney extension: Wall h700
KACL.510#I

Chimney extension: Wall h960
KACL.512#I

Chimney extension: Island h1200
KACL.557#I

Remote control
105080053

Remote motors
List at p. 219

Wall – 90/120 cm
Motor and Control
800 m³/h
3 spd + boost, electronic control
Anti-odour filters
Charcoal: type 3
Lighting
Dynamic Led Light
90 cm: 2x1,2 W (2700-5600 K)
120 cm: 3x1,2 W (2700-5600 K)
Energy Class
B
Sound pressure level
Min. speed
49 dB(A)re1pW
Max. speed
61 dB(A)re1pW
Minimum distance from cooker top
Gas hob: 63 cm
Electric hob: 52 cm
Weight
25 kg

Wall – 90 cm
Fasteel – 800 m³/h
8034122203454
Wall – 120 cm
Fasteel – 800 m³/h
8034122203157

Island – 90 cm
Motor and Control
800 m³/h
3 spd + boost, electronic control
Anti-odour filters
Charcoal: type 3
Lighting
Dynamic Led Light
90 cm: 4x1,2 W (2700-5600 K)
Energy Class
B
Sound pressure level
Min. speed
49 dB(A)re1pW
Max. speed
61 dB(A)re1pW
Minimum distance from cooker top
Gas hob: 63 cm
Electric hob: 52 cm
Weight
31 kg

Island – 90 cm
Fasteel – 800 m³/h
8034122202907

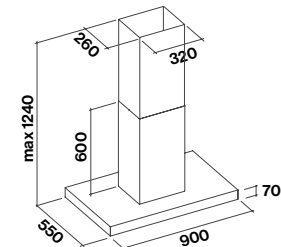
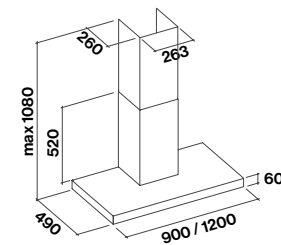



Altair

- Scotch Brite stainless steel (AISI 304)
- Perimeter suction
- Electronic control
- Led lighting
- Metallic grease filter, removable and washable
- Charcoal filter included

Optional accessories

Remote motors
List at p. 219

Wall/Island
60 cm
Motor and Control
800 m³/h
3 spd + boost, electronic control
Anti-odour filters
Charcoal: type 6
Lighting
Wall: Led 2x1,2 W (3200 K)
Island: Led 4x1,2 W (3200 K)
Energy Class
B
Sound pressure level
Min. speed
49 dB(A)re1pW
Max. speed
61 dB(A)re1pW
Minimum distance from cooker top
Gas hob: 61 cm
Electric hob: 52 cm
Weight
Wall 60 cm version: 25 kg
Island 60 cm version: 37 kg

Wall – 60 cm
800 m³/h
8034122340463

Island – 60 cm
800 m³/h
8034122340234

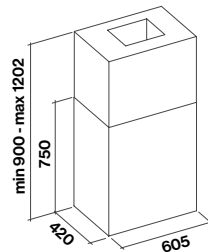
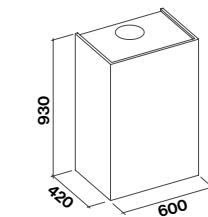

Laguna

- Scotch Brite stainless steel (AISI 304)
- Finishing tempered glass: white or black
- Available for customisable panel
- Perimeter suction
- Touch control + 24 h function
- Led lighting
- Metallic grease filter, removable and washable
- Charcoal filter included

Optional accessories

Remote motors
List at p. 219

Wall – 60/90 cm
Motor and Control
800 m³/h
3 spd + boost, touch control
Anti-odour filters
Charcoal: type 6
Lighting
Led 2x1,2 W (3200 K)
Energy Class
B
Sound pressure level
Min. speed
49 dB(A)re1pW
Max. speed
61 dB(A)re1pW
Minimum distance from cooker top
Gas hob: 60 cm
Electric hob: 52 cm
Weight
60 cm glass version: 34 kg
90 cm glass version: 45 kg

Island – 60/90 cm
Motor and Control
800 m³/h
3 spd + boost, touch control (electronic control 3 spd + boost for customisable version)
Anti-odour filters
Charcoal: type 6
Lighting
Led 4x1,2 W (3200 K)
Energy Class
B
Sound pressure level
Min. speed
49 dB(A)re1pW
Max. speed
61 dB(A)re1pW
Minimum distance from cooker top
Gas hob: 60 cm
Electric hob: 52 cm
Weight
60 cm custom version: 30 kg
90 cm custom version: 38 kg
60 cm glass version: 46 kg
90 cm glass version: 59 kg

Wall – 60 cm
White – 800 m³/h
8034122350905 (Steel body)
KACL.824#F (Glass kit)
Wall – 60 cm
Black – 800 m³/h
8034122350905 (Steel body)
KACL.824#N (Glass kit)
Wall – 90 cm
White – 800 m³/h
8034122350912 (Steel body)
KACL.825#F (Glass kit)
Wall – 90 cm
Black – 800 m³/h
8034122350912 (Steel body)
KACL.825#N (Glass kit)

Island – 60 cm
White – 800 m³/h
8034122319193 (Steel body)
KACL.822#F (Glass kit)
Island – 60 cm
Black – 800 m³/h
8034122319193 (Steel body)
KACL.822#N (Glass kit)
Island – 60 cm
Customisable* – 800 m³/h
8034122349367
Island – 90 cm
White – 800 m³/h
8034122319339 (Steel body)
KACL.823#F (Glass kit)
Island – 90 cm
Black – 800 m³/h
8034122319339 (Steel body)
KACL.823#N (Glass kit)
Island – 90 cm
Customisable* – 800 m³/h
8034122349374

White/Black/Customisable

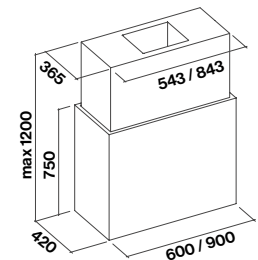
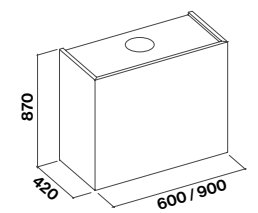

*Custom version, wooden panel to be supplied by the customer. For this version, electronic control is placed on the bottom.



Polar X NEW

- Scotch Brite stainless steel (AISI 304)
- Electronic control
- Led lighting
- Top filter removable and washable
- Charcoal filter included

Optional accessories

Remote motors
List at p. 219

Wall/island – 35 cm
Motor and Control
 800 m³/h
 3 spd + boost, electronic control
Anti-odour filters
 Charcoal: type 6
Lighting
 Led 3x1,2 W (3200 K)
Energy Class
 B
Sound pressure level
Min. speed
 48 dB(A)re1pW
Max. speed
 61 dB(A)re1pW
Minimum distance from cooker top
 Gas hob: 60 cm
 Electric hob: 52 cm
Weight
 Wall version: 23 kg
 Island version: 24 kg

Wall – 35 cm
 Steel – 800 m³/h
8034122363202

Island – 35 cm
 Steel – 800 m³/h
8034122363196

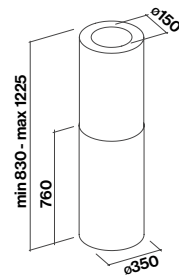
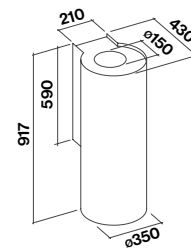

Polar Light

- Scotch Brite stainless steel (AISI 304)
- Electronic control
- Led lighting
- Led ambient light
- Top filter removable and washable
- Charcoal filter included

Optional accessories

Remote motors
List at p. 219

Wall/Island – 35 cm
Motor and Control
 800 m³/h
 3 spd + boost, electronic control
Anti-odour filters
 Charcoal: type 6
Lighting
 Led 3x1,2 W (3200 K)
 Led stripe
 5W (5500 K)
Energy Class
 B
Sound pressure level
Min. speed
 48 dB(A)re1pW
Max. speed
 61 dB(A)re1pW
Minimum distance from cooker top
 Gas hob: 60 cm
 Electric hob: 52 cm
Weight
 24 kg

Wall – 35 cm
 800 m³/h
8034122332307

Island – 35 cm
 800 m³/h
8034122331812

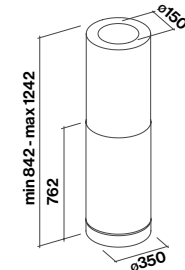
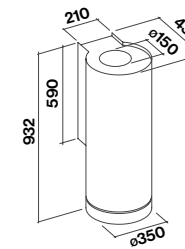

Polar

- Scotch Brite stainless steel (AISI 304)
- Electronic control
- Led lighting
- Top filter removable and washable
- Charcoal filter included

Optional accessories

Glass island
KACL.802

Remote motors
List at p. 219

Wall/Island – 35 cm
Motor and Control
 800 m³/h
 3 spd + boost, electronic control
Anti-odour filters
 Charcoal: type 6
Lighting
 Led 3x1,2 W (3200 K)
Energy Class
 B
Sound pressure level
Min. speed
 48 dB(A)re1pW
Max. speed
 61 dB(A)re1pW
Minimum distance from cooker top
 Gas hob: 60 cm
 Electric hob: 52 cm
Weight
 Wall version: 23 kg
 Island version: 24 kg

Wall – 35 cm
 800 m³/h
8034122332239

Island – 35 cm
 800 m³/h
8034122331683

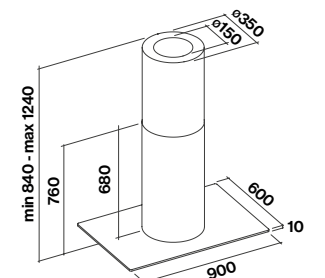
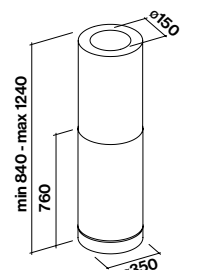
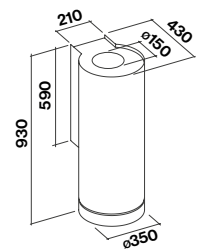

Island version with glass (optional)



Polar Black/White

- Painted white or black matte steel
- Electronic control
- Led lighting
- Top filter removable and washable
- Charcoal filter included

Optional accessories

Remote motors
List at p. 219

Wall/island – 35 cm
Motor and Control
 800 m³/h
 3 spd + boost, electronic control
Anti-odour filters
 Charcoal: type 6
Lighting
 Led 4x1,2 W (3200 K)
Energy Class
 B
Sound pressure level
Min. speed
 48 dB(A)re1pW
Max. speed
 61 dB(A)re1pW
Minimum distance from cooker top
 Gas hob: 60 cm
 Electric hob: 52 cm
Weight
 Wall version: 23 kg
 Island version: 24 kg

Wall – 35 cm
 White – 800 m³/h
8034122342146
Wall – 35 cm
 Black – 800 m³/h
8034122354620

Island – 35 cm
 White – 800 m³/h
8034122342139
Island – 35 cm
 Black – 800 m³/h
8034122354613

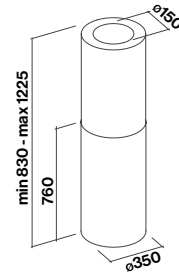
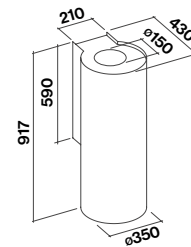

Black / White



Polar Copper/Gold

- Painted copper or gold matte steel
- Electronic control
- Led lighting
- Top filter removable and washable
- Charcoal filter included

Optional accessories

Remote motors
List at p. 219

Wall/island – 35 cm
Motor and Control
 800 m³/h
 3 spd + boost, electronic control
Anti-odour filters
 Charcoal: type 6
Lighting
 Led 4x1,2 W (3200 K)
Energy Class
 B
Sound pressure level
Min. speed
 48 dB(A)re1pW
Max. speed
 61 dB(A)re1pW
Minimum distance from cooker top
 Gas hob: 60 cm
 Electric hob: 52 cm
Weight
 Wall version: 23 kg
 Island version: 24 kg

Wall – 35 cm
 Copper – 800 m³/h
8034122361215
Wall – 35 cm
 Gold – 800 m³/h
8034122361239

Island – 35 cm
 Copper – 800 m³/h
8034122361178
Island – 35 cm
 Gold – 800 m³/h
8034122361192

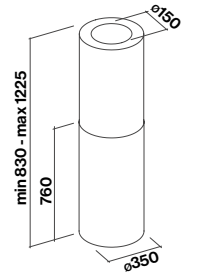
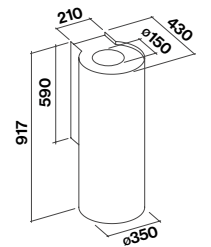

Copper / Gold



Life inspired.



Mira Black/White

- Painted white or black matte steel
- Perimeter suction
- Electronic control
- Led lighting
- Metallic grease filter, removable and washable
- Charcoal filter included

Optional accessories

Remote motors
List at p. 219

Wall/Island – 40 cm

Motor and Control

800 m³/h
3 spd + boost, electronic control

Anti-odour filters

Charcoal: type 6

Lighting

Wall: Led 2x1,2 W (3200 K)
Island: Led 4x1,2 W (3200 K)

Energy Class

B

Sound pressure level

Min. speed

48 dB(A)re1pW

Max. speed

61 dB(A)re1pW

Minimum distance from cooker top

Gas hob: 60 cm

Electric hob: 52 cm

Weight

Wall version: 21 kg

Island version: 34 kg

Wall – 40 cm

White – 800 m³/h

8034122342061

Wall – 40 cm

Black – 800 m³/h

8034122359847

Island – 40 cm

White – 800 m³/h

8034122342054

Island – 40 cm

Black – 800 m³/h

8034122359830

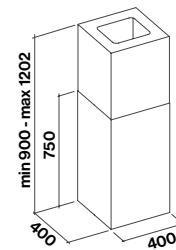
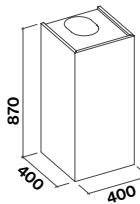

ISLAND
without extension:
chimney H 750 mm
with extension:
chimney H min. 900 mm - max 1202 mm.

Design
Mira Black/White





Mira

- Scotch Brite stainless steel (AISI 304)
- Perimeter suction
- Electronic control
- Led lighting
- Metallic grease filter, removable and washable
- Charcoal filter included

Optional accessories

Remote motors
List at p. 219

Wall/Island – 40 cm
Motor and Control
 800 m³/h
 3 spd + boost, electronic control
Anti-odour filters
 Charcoal Type 6
Lighting
 Wall: Led 2x1,2 W (3200 K)
 Island: Led 4x1,2 W (3200 K)
Energy Class
 B
Sound pressure level
Min. speed
 49 dB(A)re1pW
Max. speed
 61 dB(A)re1pW
Minimum distance from cooker top
 Gas hob: 60 cm
 Electric hob: 52 cm
Weight
 Wall version: 16 kg
 Wall telescopic version: 19 kg
 Island version: 32 kg

Wall – 40 cm
 800 m³/h
8034122206004
Wall telescopic – 40 cm
 800 m³/h
8034122205793
Island – 40 cm
 800 m³/h
8034122201993

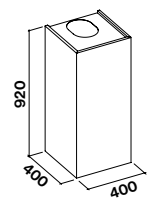

Wall version

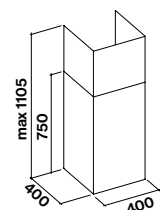

Wall telescopic version

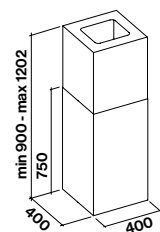

Island version



Exploit (Fasteel)

- Scotch Brite Fasteel no finger prints
- Perimeter suction
- Electronic control
- Led lighting
- Metallic grease filter, removable and washable
- Charcoal filter included

Optional accessories

Remote motors
List at p. 219

Wall/Island – 90 cm
Motor and Control
 800 m³/h
 3 spd + boost, electronic control
Anti-odour filters
 Charcoal: type 3
Lighting
 Wall: Led 2x1,2 W (3200 K)
 Island: Led 4x1,2 W (3200 K)
Energy Class
 B
Sound pressure level
Min. speed
 49 dB(A)re1pW
Max. speed
 61 dB(A)re1pW
Minimum distance from cooker top
 Gas hob: 60 cm
 Electric hob: 52 cm
Weight
 Wall version: 20 kg
 Island version: 32 kg

Exploit – Wall – 90 cm
 Stratox/Fasteel – 800 m³/h
8034122100654

Exploit – Island – 90 cm
 Stratox/Fasteel – 800 m³/h
8034122100371

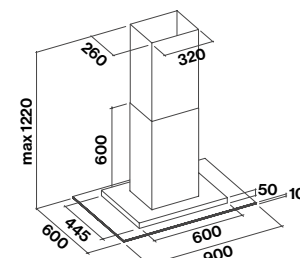
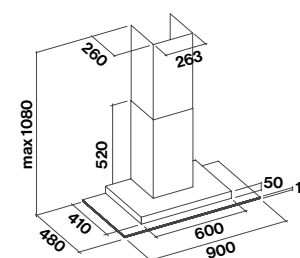

Luce

- Scotch Brite stainless steel (AISI 304)
- Black glass front
- Touch control
- Led lighting
- Ambient light
- Top filter, removable and washable
- Charcoal filter included

Optional accessories

Remote motors
List at p. 219

Wall/Island – 90 cm
Motor and Control
 800 m³/h
 3 spd + boost, touch control
Anti-odour filters
 Charcoal: type 3
Lighting
 Wall: Neon 1x21 W (6500 K)
 Island: Neon 2x21 W (6500 K)
Energy Class
 B
Sound pressure level
Min. speed
 49 dB(A)re1pW
Max. speed
 62 dB(A)re1pW
Minimum distance from cooker top
 Gas hob: 63 cm
 Electric hob: 52 cm
Weight
 Wall: 21 kg
 Island: 32 kg

Wall – 90 cm
 Black – 800 m³/h
8034122348261

Island – 90 cm
 Black – 800 m³/h
8034122348247

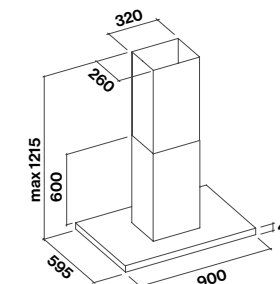
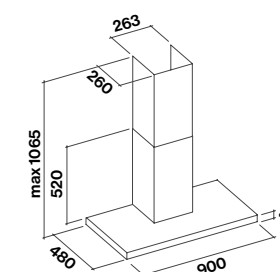



Design
Prestige



reddot design award
winner 2010



Emo Design

Prestige

- Scotch Brite stainless steel (AISI 304)
- Curved tempered glass, black or white version
- Electronic control
- Led lighting
- Led ambient light
- Top filter removable and washable
- Charcoal filter included
- Rear outlet available

Optional accessories

Remote motors
List at p. 219

Wall – 65 cm
Motor and Control
 800 m³/h
 3 spd + boost, electronic control
Anti-odour filters
 Charcoal: type 6
Lighting
 Led 4x1,2 W (4200 K)
 Led stripe
 7 W (4200 K)
Energy Class
 B
Sound pressure level
Min. speed
 54 dB(A)re1pW
Max. speed
 63 dB(A)re1pW
Minimum distance from cooker top
 Gas hob: 60 cm
 Electric hob: 52 cm
Weight
 22 kg

White – 800 m³/h
8034122329109
Wall – 65 cm
 Black – 800 m³/h
8034122329116

Island – 75 cm
Motor and Control
 800 m³/h
 3 spd + boost, electronic control
Anti-odour filters
 Charcoal: type 6
Lighting
 Led 4x1,2 W (4200 K)
 Led stripe
 13 W (4200 K)
Energy Class
 B
Sound pressure level
Min. speed
 54 dB(A)re1pW
Max. speed
 63 dB(A)re1pW
Minimum distance from cooker top
 Gas hob: 60 cm
 Electric hob: 52 cm
Weight
 40 kg

Island – 75 cm
 White – 800 m³/h
8034122342115
Island – 75 cm
 Black – 800 m³/h
8034122342122

White glass/Black glass

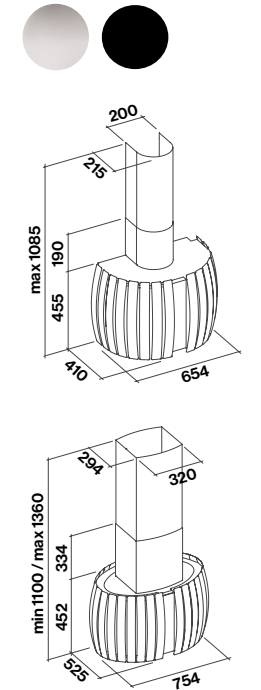

ISLAND. Without extension: chimney H 786 mm/with extension: chimney H min. 1100 mm - max 1360 mm.



Manhattan



Elektra

Mirabilia

**Pharo
Manhattan
Elektra**

- Scotch Brite stainless steel (AISI 304)
- Decorated glass
- Perimeter suction
- Electronic control
- Led lighting
- Led ambient light
- Metallic grease filter, removable and washable
- Charcoal filter included
- Back outlet available

Optional accessories

Remote motors
List at p. 219

**Island – 65/85 cm
Motor and Control**
800 m³/h
3 spd + boost, electronic control
Anti-odour filters
Charcoal: type 6
Lighting
Led 4x1,2 W (3200 K)
Ambient 4x1,2 W (3200 K)
Energy Class
B
Sound pressure level
Min. speed
54 dB(A)re1pW
Max. speed
63 dB(A)re1pW
Minimum distance from cooker top
Gas hob: 60 cm
Electric hob: 52 cm
Weight
65 cm: 31 kg
85 cm: 41 kg

Island – 65 cm*
800 m³/h
**Pharo
Manhattan
Elektra**

Codes:
8034122349077 (Steel chassis)
KACL.277 (Glass kit Manhattan)
KACL.274 (Glass kit Elektra)
KACL.276 (Glass kit Pharo)

Island – 85 cm*
800 m³/h
**Pharo
Manhattan
Elektra**

Codes:
8034122342405 (Steel chassis)
KACL.229 (Glass kit Manhattan)
KACL.226 (Glass kit Elektra)
KACL.228 (Glass kit Pharo)

**Wall – 67 cm
Motor and Control**
800 m³/h
3 spd + boost, electronic control
Anti-odour filters
Charcoal: type 6
Lighting
Led 2x1,2 W (3200 K)
Ambient 3x1,2 W (3200 K)
Energy Class
B
Sound pressure level
Min. speed
45 dB(A)re1pW
Max. speed
55 dB(A)re1pW
Minimum distance from cooker top
Gas hob: 60 cm
Electric hob: 52 cm
Weight
24 kg

Wall – 67 cm*
800 m³/h
**Pharo
Manhattan
Elektra**

Codes:
8034122342429 (Steel chassis)
KACL.217 (Glass kit Manhattan)
KACL.202 (Glass kit Elektra)
KACL.200 (Glass kit Pharo)

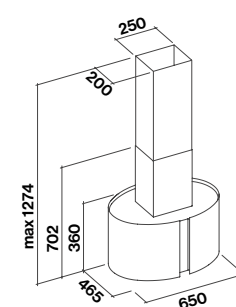
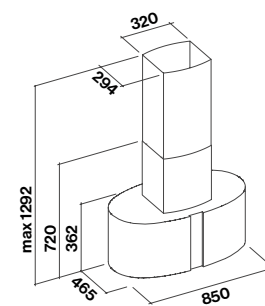
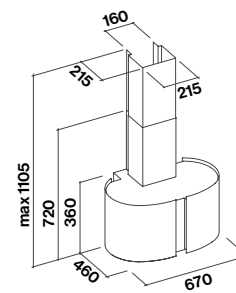

*The hood is composed by body and glass kit





Design. Wall.

The wall hood is traditionally the most used option, perfect for optimal fume extraction, if chosen and installed correctly. This solution combines functionality and design, often representing a decorative element of separation and customisation of the kitchen.



Life inspired.



Cover NEW

- Black painted body
- Openable glass front door
- Frontal panel finishing:
Black or white glass
- Sprinkled clay
- Electronic control
- Metallic grease filter,
removable and washable
- Dynamic led light

Optional accessories

Anti-odour filters
Filter: Carbon.Zeo
KACL.961

Chimney optional (white)
KCCFN.00#B

Chimney optional (black)
KCCFN.00#N

Remote control
105080053

Wall – 85 cm
Motor and Control
 600 m³/h
 Compact motor
 3 spd + boost, electronic control
Anti-odour filters
 Carbon.Zeo
 KACL.961
Lighting
 Dynamic Led Light
 Led 2x1,2 W (2700-5600 K)
Energy Class
 B
Sound pressure level
Min. speed
 45 dB(A)re1pW
Max. speed
 61 dB(A)re1pW
**Minimum distance
from cooker top**
 Gas hob: 52 cm
 Electric hob: 52 cm
Weight
 18 kg

Wall – 85 cm
 White – 600 m³/h
8034122362823
Wall – 85 cm
 Black – 600 m³/h
8034122362830
Wall – 85 cm
 Sand clay – 600 m³/h
8034122363912
Wall – 85 cm
 Stone clay – 600 m³/h
8034122363905
Wall – 85 cm
 Terracotta clay – 600 m³/h
8034122363899
Wall – 85 cm
 Ardesia clay – 600 m³/h
8034122363882

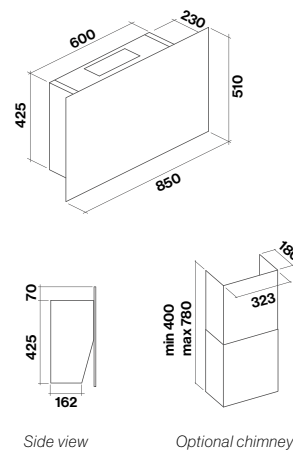

Available starting from January 2022

White/Black/Sand clay/Stone clay/Terracotta clay/Ardesia clay



Design
Cover





Clay: fruit of the earth.

Natural and malleable material par excellence, clay inherits the original colors of the land it comes from. The joint with resin elements creates a material coating that is pleasant to the touch, enriched by a manual spatula that makes the product unique. A 100% Italian product, studied in detail to create a unique style and supreme performance.

Resistant and durable thanks to the treatments it is subjected to, the "Clay" material is suitable for modern kitchen and on frequently used surfaces, resistant to heat and scratches.

The result is delicately material to the touch and refined in style, like the soft and enveloping colors of the palette. For cleaning you simply need a damp cloth.



Argilla ardesia



Argilla sabbia



Argilla pietra



Argilla terracotta



Design Saggia-Sommella

Prisma

- Tempered white or black glass
- Frontal frame in Scotch Brite stainless steel
- Touch control
- Led lighting
- Led ambient light
- Top filters removable and washable
- Charcoal filter included
- Rear outlet available

Optional accessories

Chimney optional
KCQAN.00#1

Remote motors
List at p. 219

Carbon.Zeo filtering kit
sloped hoods
List at p. 224

Wall – 85/115 cm
Motor and Control
800 m³/h
3 spd + boost, touch control
Anti-odour filters
Charcoal: 6
Lighting
Led 2x1,2 W (3200 K)
Ambient Led
2x1,2 W (3200 K)
Energy Class A
Sound pressure level
Min. speed
46 dB(A)_{re1pW}
Max. speed
58 dB(A)_{re1pW}
Minimum distance from cooker top
Gas hob: 53 cm
Electric hob: 52 cm
Weight
85 cm version: 22 kg
115 cm version: 30 kg

Wall – 85 cm
White – 800 m³/h
8034122351988
Wall – 85 cm
Black – 800 m³/h
8034122352039
Wall – 115 cm
White – 800 m³/h
8034122352015
Wall – 115 cm
Black – 800 m³/h
8034122352022

White/Black

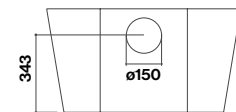
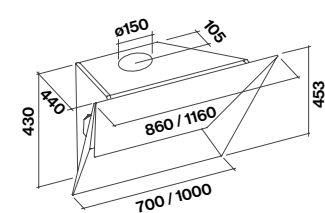

Rear view

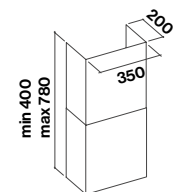

Optional chimney



Life inspired.



Design Pio&Tito Toso

Tab

- Frontal white, black, Fasteel or colored finishing
- Chrome edge
- Electronic control
- Led lighting on body and door
- Top filters removable and washable
- Charcoal filter included
- Rear outlet available

Optional accessories

- Chimney optional (Steel) KCTCN.001#I
- Chimney optional (White) KCTCN.001#B
- Chimney optional (Black) KCTCN.001#N

Remote motors

List at p. 219

- Carbon.Zeo filtering kit sloped hoods
- List at p. 224

Wall – 60/80 cm
Motor and Control
 800 m³/h
 3 spd + boost, electronic control
Anti-odour filters
 Charcoal: type 6
Lighting
 Led 4x1,2 W (3200 K)
Energy Class
 A
Sound pressure level
Min. speed
 46 dB(A)re1pW
Max. speed
 58 dB(A)re1pW
Minimum distance from cooker top
 Gas hob: 53 cm
 Electric hob: 52 cm
Weight
 60 cm version: 17 kg
 80 cm version: 21 kg

Wall – 60 cm
 White – 800 m³/h
8034122352046
Wall – 60 cm
 Black – 800 m³/h
8034122352053
Wall – 60 cm
 Fasteel – 800 m³/h
8034122352077
Wall – 80 cm
 White – 800 m³/h
8034122352091
Wall – 80 cm
 Black – 800 m³/h
8034122352107
Wall – 80 cm
 Fasteel – 800 m³/h
8034122352121

White/Black/Fasteel

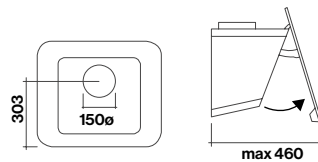
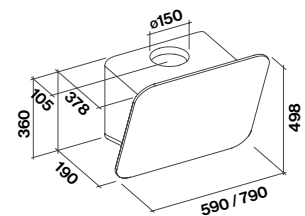

Rear view

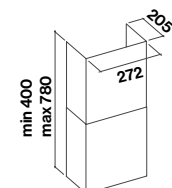

Optional chimney

Design Tab



Life inspired.



Quasar

- Scotch Brite stainless steel
- Finishing tempered glass: white, black or grey
- Perimeter suction
- Touch control + 24h function
- Dynamic Led Light
- Metallic grease filter, removable and washable
- Charcoal filter included
- Rear outlet available

Optional accessories

- Chimney optional (Steel) KCQAN.00#I
- Chimney optional (White) KCQAN.00#B
- Chimney optional (Black) KCQAN.00#N

- Remote motors
- List at p. 219

- Carbon.Zeo filtering kit sloped hoods
- List at p. 224

Wall – 60/80/90/120 cm
Motor and Control
 800 m³/h
 3 spd + boost, touch control
Anti-odour filters
 Charcoal: type 6
Lighting
 Dynamic Led Light
 60 cm
 2x1,2 W (2700-5600K)
 80/90/120 cm
 3x1,2 W (2700-5600 K)
Energy Class
 A
Sound pressure level
Min. speed
 46 dB(A)re1pW
Max. speed
 58 dB(A)re1pW
Minimum distance from cooker top
 Gas hob: 52 cm
 Electric hob: 52 cm
Weight
 60 cm version: 26 kg
 80 cm version: 31 kg
 90 cm version: 33 kg
 120 cm version: 41 kg

Wall – 60 cm
 White – 800 m³/h
8034122353975
Wall – 60 cm
 Black – 800 m³/h
8034122353982
Wall – 80 cm
 White – 800 m³/h
8034122353999
Wall – 80 cm
 Black – 800 m³/h
8034122354002
Wall – 90 cm
 White – 800 m³/h
8034122354019
Wall – 90 cm
 Black – 800 m³/h
8034122354033
Wall – 90 cm
 Grey – 800 m³/h
8034122354026
Wall – 120 cm
 White – 800 m³/h
8034122353944
Wall – 120 cm
 Black – 800 m³/h
8034122353968

White/Black/Grey RAL7022

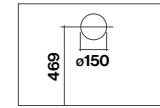
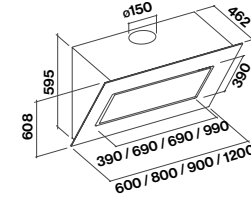

Rear view

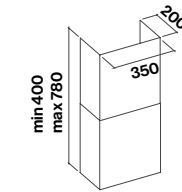

Optional chimney

Design
Quasar





Quasar Green Tech

- Scotch Brite stainless steel
- New Green Tech motor
- Finishing tempered white glass or black
- Perimeter suction
- Touch control + 24h function
- Dynamic Led Light
- Metallic grease filter, removable and washable
- New charcoal filter included
- Rear outlet available

Optional accessories

- Chimney optional (Steel) KCQAN.00#I
- Chimney optional (White) KCQAN.00#B
- Chimney optional (Black) KCQAN.00#N

- Remote motors List at p. 219

- Carbon.Zeo filtering kit sloped hoods List at p. 224

Wall – 90 cm
Motor and Control
 800 m³/h Green Tech
 3 spd + boost, touch control
Anti-odour filters
 Charcoal: ø 192 mm
Lighting
 Dynamic Led Light
 3x1,2 W (2700-5600 K)
Energy Class
 A+++
Sound pressure level
Min. speed
 45 dB(A)re1pW
Max. speed
 58 dB(A)re1pW
Minimum distance from cooker top
 Gas hob: 52 cm
 Electric hob: 52 cm
Weight
 33 kg

Wall – 90 cm
 White – 800 m³/h
8034122101804
Wall – 90 cm
 Black – 800 m³/h
8034122101811

White/Black

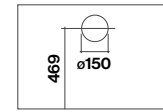
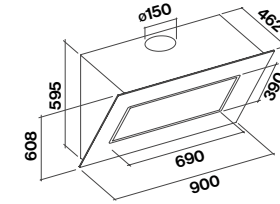

Rear view

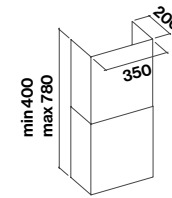

Optional chimney



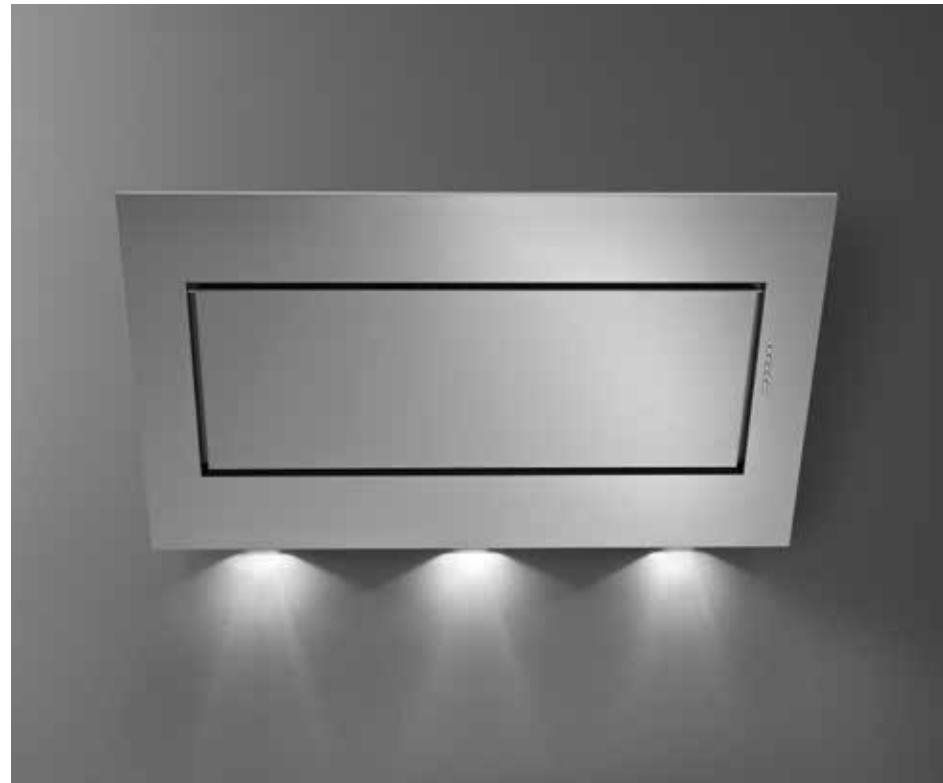

Quasar Top (Fasteel)

- Scotch Brite Fasteel no finger prints
- Perimeter suction
- Electronic control
- Led lighting
- Metallic grease filter, removable and washable
- Charcoal filter included
- Rear outlet available

Optional accessories

Chimney optional (Fasteel)
KCQAN.00#X

Remote motors
List at p. 219

Carbon.Zeo filtering kit
sloped hoods
List at p. 224

Wall – 90/120 cm
Motor and Control
800 m³/h
3 spd + boost, electronic control
Anti-odour filters
Charcoal: type 6
Lighting
Led
3x1,2 W (3200 K)
Energy Class
A
Sound pressure level
Min. speed
46 dB(A)re1pW
Max. speed
58 dB(A)re1pW
Minimum distance from cooker top
Gas hob: 52 cm
Electric hob: 52 cm
Weight
90 cm version: 28 kg
120 cm version: 37 kg

Wall – 90 cm
Fasteel – 800 m³/h
8034122205564
Wall – 120 cm
Fasteel – 800 m³/h
8034122205571

Fasteel

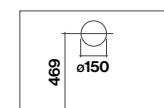
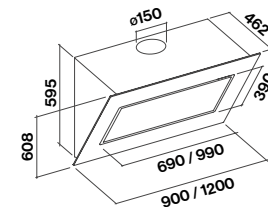

Rear view

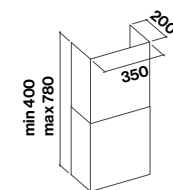

Optional chimney



Diamante

- Scotch Brite stainless steel (AISI 304)
- Perimeter suction
- Electronic control
- Neon lighting
- Metallic grease filter, removable and washable
- Charcoal filter included
- Rear outlet available

Optional accessories

Chimney optional (Steel)
KCQAN.00#I

Remote control
105080053

Remote motors
List at p. 219

Carbon.Zeo filtering kit
sloped hoods
List at p. 224

Wall – 90 cm
Motor and Control
800 m³/h
3 spd + boost, electronic control
Anti-odour filters
Charcoal: type 6
Lighting
Neon 2x13 W (6500 K)
Energy Class
B
Sound pressure level
Min. speed
45 dB(A)re1pW
Max. speed
57 dB(A)re1pW
Minimum distance from cooker top
Gas hob: 53 cm
Electric hob: 52 cm
Weight
22 kg

Wall – 90 cm
800 m³/h
8034122305837

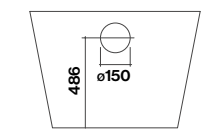
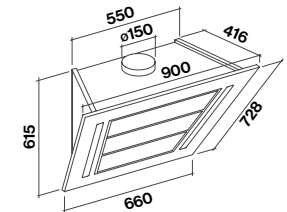

Rear view

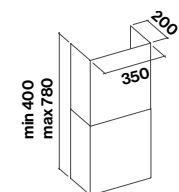

Optional chimney

Life inspired.



Flipper

- Tempered glass versions with Scotch Brite stainless steel (AISI304) central band
- Electronic control
- Led lighting
- Metallic grease filter, removable and washable
- Charcoal filter included
- Rear outlet available

Optional accessories

- Chimney optional (Steel) KCQAN.00#I
- Chimney optional (White) KCQAN.00#B
- Chimney optional (Black) KCQAN.00#N

- Remote motors
List at p. 219

- Carbon.Zeo filtering kit sloped hoods
List at p. 224

Wall – 55/85 cm
Motor and Control
800 m³/h
3 spd + boost, electronic control
Anti-odour filters
Charcoal: type 6
Lighting
Led 2x1,2 W (3200 K)
Energy Class
A
Sound pressure level
Min. speed
46 dB(A)re1pW
Max. speed
58 dB(A)re1pW
Minimum distance from cooker top
Gas hob: 52 cm
Electric hob: 52 cm
Weight
55 cm version: 17 kg
85 cm version: 25 kg

Wall – 55 cm
Satin white – 800 m³/h
8034122352190
Wall – 55 cm
Satin black – 800 m³/h
8034122352213
Wall – 85 cm
Satin white – 800 m³/h
8034122350004
Wall – 85 cm
Satin black – 800 m³/h
8034122350363
Wall – 85 cm
Satin grey – 800 m³/h
8034122350066

Satin white glass/
Satin black glass/
Gray glass RAL 7032



The RAL codes have to be considered indicative since production process and materials may alter the colours.

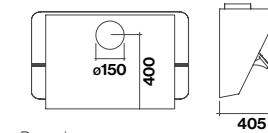
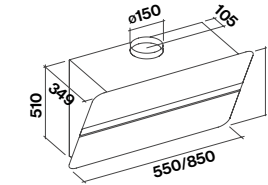

Rear view

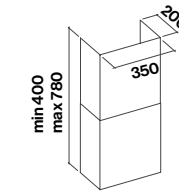

Optional chimney

Design Flipper





Design
Flipper Green Tech



Flipper Green Tech

- Tempered glass versions with Scotch Brite stainless steel (AISI304) central band
- Dynamic Led Light
- New Green Tech motor
- Electronic control
- Led lighting
- Metallic grease filter, removable and washable
- Rear outlet available
- New charcoal filter included

Optional accessories

- Chimney** optional (Steel) KCQAN.00#I
- Chimney** optional (White) KCQAN.00#B
- Chimney** optional (Black) KCQAN.00#N

Remote control
105080053

Remote motors
List at p. 219

Carbon.Zeo filtering kit
sloped hoods
List at p. 224

Wall – 85 cm
Motor and Control
800 m³/h Green Tech
3 spd + boost, electronic control
Anti-odour filters
Charcoal: ø 192 mm
Lighting
Dynamic Led Light
2x1,2 W (2700-5500 K)
Energy Class
A+++
Sound pressure level
Min. speed
45 dB(A)re1pW
Max. speed
58 dB(A)re1pW
Minimum distance from cooker top
Gas hob: 52 cm
Electric hob: 52 cm
Weight
25 kg

Wall – 85 cm
Satin white – 800 m³/h
8034122101729
Wall – 85 cm
Satin black – 800 m³/h
8034122101736

Satin white glass/
Satin black glass

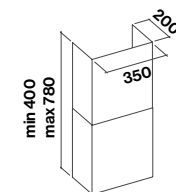
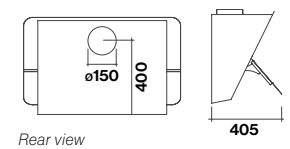
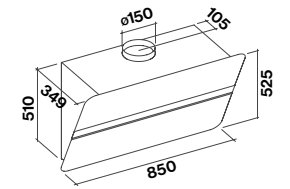

Optional chimney

Life inspired.



Verso

- Tempered white, black or grey glass
- Touch control + 24h function
- Dynamic Led Light
- Double suction area (frontal and lower)
- Frontal opening
- Metallic grease filter, removable and washable
- Charcoal filter included
- Rear outlet available

Optional accessories

Chimney optional (White)
KCQAN.00#B
Chimney optional (Black)
KCQAN.00#N

Remote motors
List at p. 219

Carbon.Zeo filtering kit
sloped hoods
List at p. 224

Wall – 55/85 cm
Motor and Control
800 m³/h
3 spd + boost, touch control
Anti-odour filters
Charcoal: type 6
Lighting
Dynamic Led Light
Led 2x1,2 W (2700-5600 K)
Energy Class
A
Sound pressure level
Min. speed
46 dB(A)re1pW
Max. speed
58 dB(A)re1pW
Minimum distance from cooker top
Gas hob: 52 cm
Electric hob: 52 cm
Weight
Version 55 cm: 17 kg
Version 85 cm: 19 kg

Wall – 55 cm
White – 800 m³/h
8034122358758
Wall – 55 cm
Black – 800 m³/h
8034122358734
Wall – 55 cm
Grey – 800 m³/h
8034122361635
Wall – 85 cm
White – 800 m³/h
8034122358765
Wall – 85 cm
Black – 800 m³/h
8034122358741
Wall – 85 cm
Grey – 800 m³/h
8034122361642

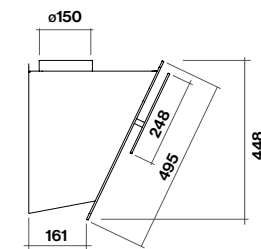
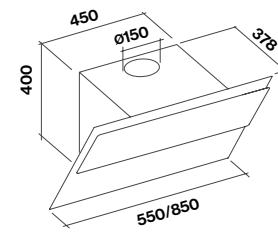

Lateral view

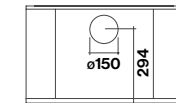

Rear view

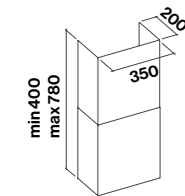

Optional chimney

Black glass/White glass/Grey glass



Design
Verso





Design
Rialto



reddot design award



Design Antoniazzi&Niolu

Rialto

- Scotch Brite stainless steel (AISI 304)
- Black satin finishing sides
- Led lighting
- Electronic control
- Top filter removable and washable
- Charcoal filter included

Optional accessories

Remote motors
List at p. 219

Wall – 55 cm
Motor and Control
 800 m³/h
 3 spd + boost, electronic control
Anti-odour filters
 Charcoal: type 6
Lighting
 Led 2x1,2 W (3200 K)
Energy Class
 B
Sound pressure level
Min. speed
 49 dB(A)re1pW
Max. speed
 59 dB(A)re1pW
Minimum distance from cooker top
 Gas hob: 50 cm
 Electric hob: 52 cm
Weight
 23 kg

Wall – 55 cm
h 1000
 800 m³/h
8034122363998

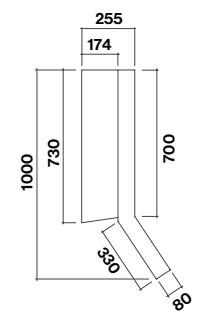
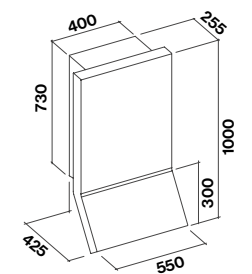

Design
Stream



Stream

- Scotch Brite stainless steel (AISI 304)
- Electronic control
- Led lighting
- Air Falmec filter for balanced suction
- Charcoal filter included

Optional accessories

Remote motors
List at p. 219

Wall – 90 cm
Motor and Control
800 m³/h
3 spd + boost, electronic control

Anti-odour filters
Charcoal: type 3

Lighting
Led 2x1,2 W (3200 K)

Energy Class
B

Sound pressure level

Min. speed
49 dB(A)re1pW

Max. speed
62 dB(A)re1pW

Minimum distance from cooker top

Gas hob: 60 cm
Electric hob: 52 cm

Weight
17 kg

Wall – 90 cm
800 m³/h
8034122331317

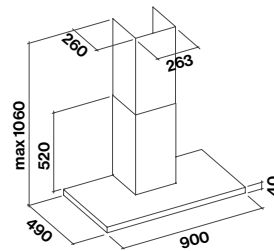

Design
Mercurio



Mercurio

- Scotch Brite stainless steel
- Electronic control
- Led lighting
- Metallic grease filter, removable and washable

Optional accessories

Anti-odour filters
Filter: Charcoal Type 3
103050107

Remote motors
List at p. 219

Wall – 60/90 cm
Motor and Control
600 m³/h
mechanic control, 3 spd

Anti-odour filters
Charcoal: type 3

Lighting
Led 2x1,2 W (3200 K)

Energy Class
C

Sound pressure level

Min. speed
49 dB(A)re1pW

Max. speed
65 dB(A)re1pW

Minimum distance from cooker top

Gas hob: 63 cm
Electric hob: 52 cm

Weight
60 cm version: 14 kg
90 cm version: 15 kg

Wall – 60 cm
600 m³/h
8034122363134

Wall – 90 cm
600 m³/h
8034122363158

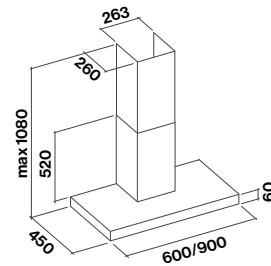

Design
Blade



Blade

- Scotch Brite stainless steel (AISI 304)
- Tempered black or white glass front
- Touch control
- Neon lighting
- Metallic filter, removable and washable
- Charcoal filter included

Optional accessories

Remote motors
List at p. 219

Wall – 90 cm
Motor and Control
800 m³/h
3 spd + boost, touch control

Anti-odour filters
Charcoal: type 3

Lighting
Neon 1x21 W (6500 K)

Energy Class
B

Sound pressure level

Min. speed
49 dB(A)re1pW

Max. speed
61 dB(A)re1pW

Minimum distance from cooker top

Gas hob: 62 cm
Electric hob: 52 cm

Weight
21 kg

Wall – 90 cm
White – 800 m³/h
8034122345307
Wall – 90 cm
Black – 800 m³/h
8034122345314

White glass/Black glass

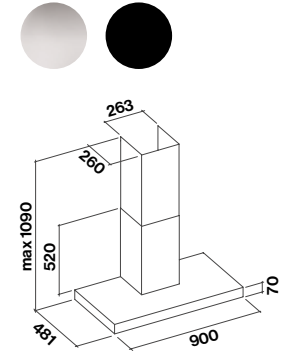



Concorde

- Scotch Brite stainless steel (AISI 304)
- Perimeter suction
- Electronic control
- Led lighting
- Metallic grease filter, removable and washable
- Charcoal filter included

Optional accessories

Remote motors
List at p. 219

Wall – 90 cm
Motor and Control
 800 m³/h
 3 spd + boost, electronic control
Anti-odour filters
 Charcoal: type 3
Lighting
 Led 2x1,2 W (3200 K)
Energy Class
 B
Sound pressure level
Min. speed
 49 dB(A)re1pW
Max. speed
 61 dB(A)re1pW
Minimum distance from cooker top
 Gas hob: 60 cm
 Electric hob: 52 cm
Weight
 22 kg

Wall – 90 cm
 800 m³/h
 8034122305271

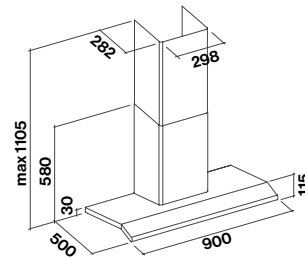

Mizar

- Scotch Brite stainless steel (AISI 304)
- Electronic control
- Led lighting
- Air Falmecc filter, removable and washable
- Charcoal filter included

Optional accessories

Remote motors
List at p. 219

Wall – 60/90 cm
Motor and Control
 800 m³/h
 3 spd + boost, electronic control
Anti-odour filters
 Charcoal: type 3
Lighting
 Led 2x1,2 W (3200 K)
Energy Class
 B
Sound pressure level
Min. speed
 49 dB(A)re1pW
Max. speed
 62 dB(A)re1pW
Minimum distance from cooker top
 Gas hob: 60 cm
 Electric hob: 52 cm
Weight
 60 cm version: 15 kg
 90 cm version: 17 kg

Wall – 60 cm
 800 m³/h
 8034122325880
Wall – 90 cm
 800 m³/h
 8034122326108

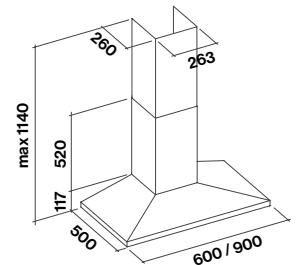



Elios

- Scotch Brite stainless steel (AISI 304)
- Electronic control
- Led lighting
- Air Falmec filter for balanced suction
- Charcoal filter included

Optional accessories

Remote motors
List at p. 219

**Corner
90/100 cm**
Motor and Control
800 m³/h
3 spd + boost,
electronic control

Anti-odour filters
Charcoal type 6
Lighting
Led 3x1,2 W (3200 K)

Energy Class
B

Sound pressure level
Min. speed
49 dB(A)re1pW

Max. speed
62 dB(A)re1pW

**Minimum distance
from cooker top**
Gas hob: 65 cm
Electric hob: 52 cm

Weight
90 cm version: 15 kg
100 cm version: 19 kg

Corner – 90 cm
800 m³/h
8034122341781
Corner – 100 cm
800 m³/h
8034122306322

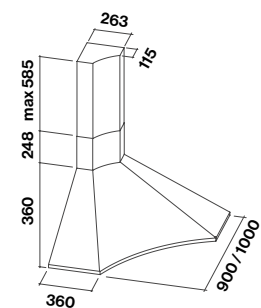

Classic
Ginevra Boston



Ginevra Boston

- Anthracite painted steel with copper front edge
- Slider
- Led lighting
- Metallic grease filter, removable and washable
- Charcoal filter included

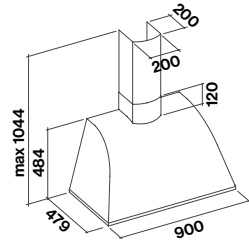

Wall – 90 cm
Motor and Control
 600 m³/h 3 spd slider
Anti-odour filters
 Charcoal: type 2
Lighting
 Led 2x2 W (2700 K)
Energy Class
 C

Sound pressure level
Min. speed
 49 dB(A)re1pW
Max. speed
 65 dB(A)re1pW
Minimum distance from cooker top
 Gas hob: 60 cm
 Electric hob: 52 cm
Weight
 18 kg

Wall – 90 cm
 600 m³/h
 8034122409948

Classic
Mimosa



Mimosa

- White painted steel
- Slider
- Natural ash solid wood
- Led lighting
- Metallic grease filter, removable and washable
- Charcoal filter included

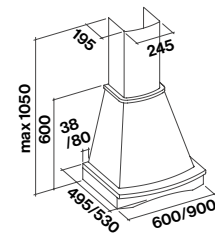

Wall
60/90 cm
Motor and Control
 600 m³/h 3 spd slider
Anti-odour filters
 Charcoal: type 2
Lighting
 Led 2x2 W (2700 K)
Energy Class
 C

Sound pressure level
Min. speed 49 dB(A)re1pW
Max. speed 65 dB(A)re1pW
Minimum distance from cooker top
 Gas hob: 60 cm
 Elettrico hob: 52 cm
Weight
 60 cm version: 15 kg
 90 cm version: 18 kg

Wall – 60 cm
 600 m³/h
 8034122477770
Wall – 90 cm
 600 m³/h
 8034122477602

Classic
Mimosa



Life inspired.



Design. Built-in.

Built-in hoods, integrated into the wall unit, grant linearity and optimization of the spaces in the kitchen; they are therefore recommended in environments with an essential design or where there is the need to maximize the space on the wall.



Life inspired.





Virgola

Virgola

- Scotch Brite stainless steel or matte black painted steel
- Tempered turning glass flap (smoked glass on black version)
- Electronic control
- Dynamic Led Light
- Metallic grease filter, removable and washable
- Charcoal filter included
- Rear outlet available

Optional accessories

Anti-odor filter
Filter Carbon.Zeo regenerable
KACL.961
Filter Carbon
KACL.960

Glass Shelf 60 cm
KACL.106
Glass Shelf 90 cm
KACL.107
Glass Shelf 120 cm
KACL.108

Chimney
Steel Version

Telescopic chimney 185+185 mm
KCVJN.00#3
Chimney 120 mm
KCVJN.01#3

Black Matt Version

Telescopic chimney 185+185 mm
KCVJN.00#N
Chimney 120 mm
KCVJN.01#N

Built-in
60/75/90/120 cm
Motor and Control
600 m³/h
Electronic control 3 speed
Anti-odour filters
Carbon.Zeo regenerable
Carbon
Lighting
Dynamic Led Light
60/75/90 cm
2x1,2 W (2700-5600 K)
120 cm
4x1,2 W (2700-5600 K)
Energy Class
B
Sound pressure level
Min. speed
49 dB(A)re1pW
Max. speed
65 dB(A)re1pW
Minimum distance from cooker top
Gas hob: 52 cm
Electric hob: 52 cm
Weight
60 cm version: 9 kg
75 cm version: 11 kg
90 cm version: 12 kg
120 cm version: 14 kg

Steel version

Built-in – 60 cm
Steel – 600 m³/h
8034122363448
Built-in – 75 cm
Steel – 600 m³/h
8034122363530
Built-in – 90 cm
Steel – 600 m³/h
8034122363561
Built-in – 120 cm
Steel – 600 m³/h
8034122363356

Black matt version

Built-in – 60 cm
Black – 600 m³/h
8034122363462
Built-in – 90 cm
Black – 600 m³/h
8034122363585
Built-in – 120 cm
Black – 600 m³/h
8034122363370

Black/Steel

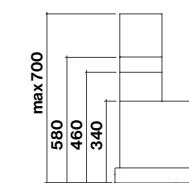
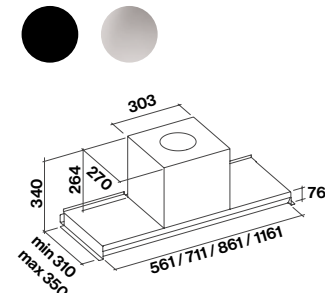

Side view with optional chimney

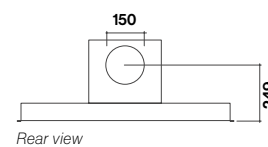

Rear view

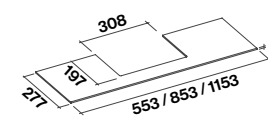

Optional shelf



Virgola Black



Move

- Scotch Brite stainless steel (AISI 304)
- Black or white tempered glass
- Sliding door
- Electronic control
- Dynamic Led Light
- Metallic grease filter, removable and washable
- Rear outlet available

Optional accessories

Anti-odour filters
Filter: Carbon.Zeo regenerable
KACL.961

Glass Shelf 60 cm
KACL.106
Glass Shelf 90 cm
KACL.107
Glass Shelf 120 cm
KACL.108

Telescopic Chimney 185+185 mm
KCVJN.00#3
Chimney 120 mm
KCVJN.01#3

Remote motors
List at p. 219

Built-in – 60/90/120 cm
Motor and Control
800 m³/h
3 spd + boost, electronic control
Anti-odour filters
Optional Carbon.Zeo filter
Lighting
Dynamic Led Light
60 cm: 2x1,2 W (2700-5600 K)
90/120 cm: 3x1,2 W (2700-5600 K)

Energy Class
B
Sound pressure level
Min. speed
49 dB(A)re1pW
Max. speed
62 dB(A)re1pW
Minimum distance from cooker top
Gas hob: 52 cm
Electric hob: 52 cm
Weight
60 cm version: 14 kg
90 cm version: 17 kg
120 cm version: 20 kg

Built-in – 60 cm
White – 800 m³/h
8034122352152
Built-in – 60 cm
Black – 800 m³/h
8034122352169
Built-in – 90 cm
White – 800 m³/h
8034122352176
Built-in – 90 cm
Black – 800 m³/h
8034122352183
Built-in – 120 cm
White – 800 m³/h
8034122353333
Built-in – 120 cm
Black – 800 m³/h
8034122353326

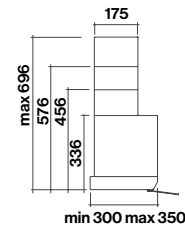
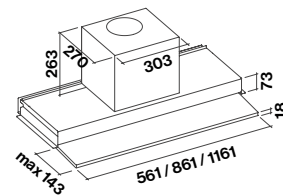

Side view with optional chimney

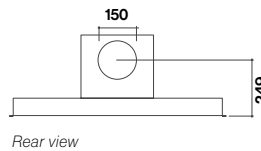

Rear view

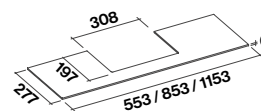

Shelf optional



Move Green Tech

- Scotch Brite stainless steel (AISI 304)
- New Green Tech motor
- Black or white tempered glass
- Sliding door
- Electronic control
- Dynamic Led Light
- Metallic grease filter, removable and washable
- Rear outlet available

Optional accessories

Anti-odour filters
Filter: Carbon.Zeo regenerable
KACL.961

Glass Shelf 90 cm
KACL.107

Telescopic Chimney 185+185 mm
KCVJN.00#3
Chimney 120 mm
KCVJN.01#3

Built-in – 90 cm
Motor and Control
800 m³/h Green Tech
3 spd + boost, electronic control
Anti-odour filters
Optional Carbon.Zeo filter
Lighting
Dynamic Led Light
3x1,2 W (2700-5600 K)

Energy Class
A++
Sound pressure level
Min. speed
48 dB(A)re1pW
Max. speed
62 dB(A)re1pW
Minimum distance from cooker top
Gas hob: 52 cm
Electric hob: 52 cm
Weight
17 kg

Built-in – 90 cm
White – 800 m³/h
8034122101828
Built-in – 90 cm
Black – 800 m³/h
8034122101835

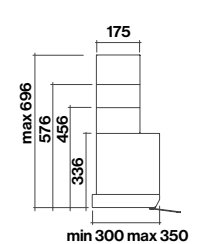
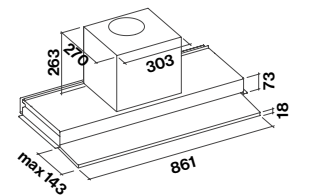

Side view with optional chimney

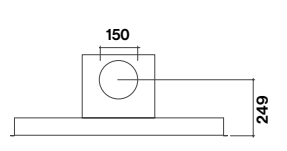

Rear view

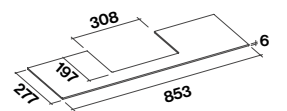

Shelf optional



Gruppo Incasso

- Scotch Brite stainless steel (AISI 304)
- Perimeter suction
- Electronic control
- Dynamic Led Light
- Metallic grease filter, removable and washable
- Charcoal filter included

Optional accessories

Remote control
105080053

Remote motors*
List at p. 219

Filtering kit Carbon.Zeo
built-in
List at p. 225

*800 m³/h version only

Built-in
50/70/105 cm
Motor and Control
600 m³/h
Electronic control 3 speed
800 m³/h
3 spd + boost, electronic control
Filters antiodore
Charcoal: type 6
Lighting
Dynamic Led Light
50/70 cm
2x1,2 W (2700-5600 K)
105 cm
4x1,2 W (2700-5600 K)
Energy Class
600 m³/h: C
800 m³/h: B
Sound pressure level
Min. speed
49 dB(A)_{re1pW}**
Max. speed
61 dB(A)_{re1pW}**
Minimum distance from cooker top
Gas hob: 62 cm
Electric hob: 52 cm
Weight
50 cm version: 8 kg
70 cm version: 10 kg
105 cm version: 15 kg

**value refers to 600 m³/h version

Built-in – 50 cm
600 m³/h
8034122353388
Built-in – 50 cm
800 m³/h
8034122353395
Built-in – 70 cm
600 m³/h
8034122353401
Built-in – 70 cm
800 m³/h
8034122353418
Built-in – 105 cm
800 m³/h
8034122353371

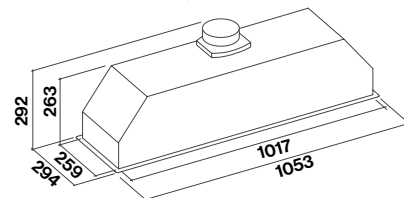
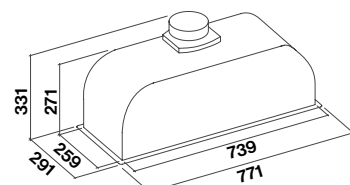
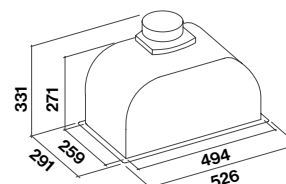
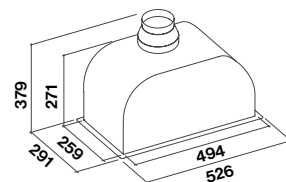

Cut-out size
50 cm: 506 mm x 262 mm
70 cm: 751 mm x 262 mm
105 cm: 1029 mm x 262 mm





Gruppo Incasso Green Tech

- Scotch Brite stainless steel (AISI 304)
- New Green Tech motor
- Perimeter suction
- Electronic control
- Dynamic Led Light
- Metallic grease filter, removable and washable
- New charcoal filter included

Optional accessories

Remote control
105080053

Remote motors
List at p. 219

Filtering kit Carbon.Zeo
built-in
List at p. 225

Built-in 50/70 cm Motor and Control
800 m³/h Green Tech
3 spd + boost, electronic control

Anti-odour filters
Charcoal: ø 192 mm

Lighting
Dynamic Led Light
2x1,2 W (2700-5600 K)

Energy Class
A+

Sound pressure level

Min. speed
47 dB(A)re1pW

Max. speed
61 dB(A)re1pW

Minimum distance from cooker top
Gas hob: 62 cm
Electric hob: 52 cm

Weight
50 cm version: 8 kg
70 cm version: 10 kg

Built-in – 50 cm
800 m³/h
8034122101743

Built-in – 70 cm
800 m³/h
8034122101750

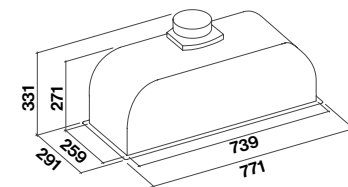
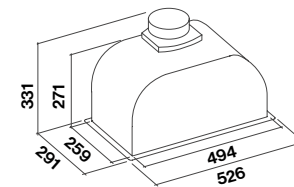

Cut-out size
50 cm: 506 mm x 262 mm
70 cm: 751 mm x 262 mm



Gruppo Incasso Touch Vision

- Scotch Brite stainless steel (AISI 304)
- Perimeter suction
- Ergonomic Touch Vision control with color-coded speed
- Dynamic Led Light
- Metallic grease filter, removable and washable
- Charcoal filter included

Optional accessories

Remote motors
List at p. 219

Filtering kit Carbon.Zeo
built-in
List at p. 225

Built-in 50/70 cm Motor and Control
800 m³/h
Touch Vision control
3 spd + boost

Anti-odour filters
Charcoal: type 6

Lighting
Dynamic Led Light
2x1,2 W (2700-5600 K)

Energy Class
B

Sound pressure level

Min. speed
49 dB(A)re1pW

Max. speed
65 dB(A)re1pW

Minimum distance from cooker top
Gas hob: 62 cm
Electric hob: 52 cm

Weight
50 cm version: 8 kg
70 cm version: 10 kg

Built-in – 50 cm
800 m³/h
8034122359748

Built-in – 70 cm
800 m³/h
8034122359755

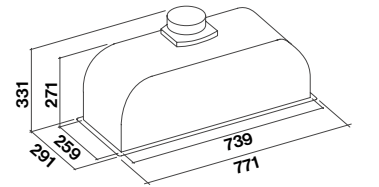
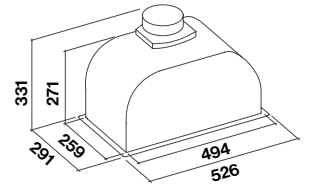

Cut-out size
50 cm: 506 mm x 262mm
70 cm: 751 mm x 262 mm



Gruppo Incasso Murano

- Tempered extra-light white or black glass
- Perimeter suction
- Touch control + 24h function
- Dynamic Led Light
- Metallic grease filter, removable and washable
- Charcoal filter included
- Remote control included

Optional accessories

Remote motors
List at p. 219

Filtering kit Carbon.Zeo
built-in
List at p. 225

Built-in 50/70 cm Motor and Control
800 m³/h
3 spd + boost, touch control
Anti-odour filters
Charcoal: type 6
Lighting
Dynamic Led Light
2x2,4 W (2700-5600 K)
Energy Class
B
Sound pressure level
Min. speed
49 dB(A)re1pW
Max. speed
61 dB(A)re1pW
Minimum distance from cooker top
Gas hob: 62 cm
Electric hob: 52 cm
Weight
50 cm version: 9 kg
70 cm version: 11 kg

Built-in – 50 cm
White - 800 m³/h
8034122348391
Built-in – 70 cm
White - 800 m³/h
8034122348407

Built-in – 50 cm
Black - 800 m³/h
8034122359458
Built-in – 70 cm
Black - 800 m³/h
8034122359465

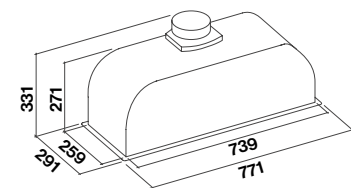
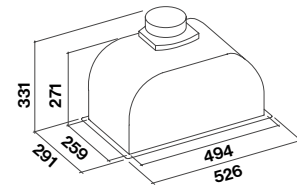

Cut-out size
50 cm: 506 mm x 262 mm
70 cm: 751 mm x 262 mm

Black/White



Built-in

- Scotch Brite stainless steel
- Mechanical slider
- Led lighting
- Metallic grease filter, removable and washable

Optional accessories

Anti-odour filters
Carbon Filter Type 6
103050091 (pair)

Remote motors
List at p. 219

Built-in – 50/70 cm Motor and Control
600 m³/h
mechanic control, 3 spd
Anti-odour filters
Charcoal: type 6
Lighting
Led 2x1,2 W (3200 K)
Energy Class
C
Sound pressure level
Min. speed
49 dB(A)re1pW
Max. speed
65 dB(A)re1pW
Minimum distance from cooker top
Gas hob: 64 cm
Electric hob: 52 cm
Weight
50 cm version: 7 kg
70 cm version: 9 kg

Built-in – 50 cm
600 m³/h
8034122504391

Built-in – 70 cm
600 m³/h
8034122504407

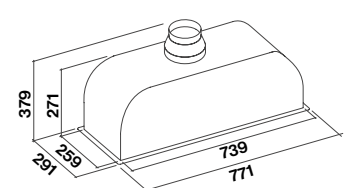
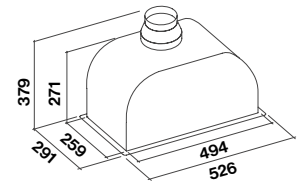

Cut-out size
50 cm: 506 mm x 262 mm
70 cm: 751 mm x 262 mm



Professional.

The hood for haute cuisine.

Powerful motors, professional baffle filters, a receptacle for cooking greases.

A blend of the typical features of the kind of extractor hoods used in the best restaurants, to fit your space and your needs.





Zeus Pro

- Scotch Brite stainless steel (AISI 304)
- Oil collector
- Electronic control
- Led lighting
- Professional baffle filters
- Back outlet available

Optional accessories

Chimney optional
KCQAN.00#1

Remote motors
List at p. 219

Wall – 90/120 cm
Motor and Control
 950 m³/h
 Electronic control 3 speed + boost
Metallic filters
 Baffle
Lighting
 Led
 90 cm: 3x1,2 W (3200 K)
 120 cm: 4x1,2 W (3200 K)
Energy Class
 A
Sound pressure level
Min. speed
 53 dB(A)re1pW
Max. speed
 64 dB(A)re1pW
Minimum distance from cooker top
 Gas hob: 63 cm
 Electric hob: 52 cm
Weight
 90 cm version: 25 kg
 120 cm version: 31 kg

Wall – 90 cm
 950 m³/h
8034122355313
Wall – 120 cm
 950 m³/h
8034122355306

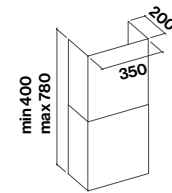
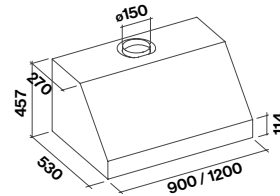

Chimney optional

Marte Pro

- Scotch Brite stainless steel (AISI 304)
- Oil collector
- Electronic control
- Led lighting
- Professional baffle filters

Optional accessories

Remote motors
List at p. 219

Wall – 90/120 cm
Motor and Control
 950 m³/h
 3 spd + boost, electronic control
Metallic filters
 Baffle
Lighting
 Led
 90 cm: 3x1,2 W (3200 K)
 120 cm: 4x1,2 W (3200 K)
Energy Class
 A
Sound pressure level
Min. speed
 53 dB(A)re1pW
Max. speed
 64 dB(A)re1pW
Minimum distance from cooker top
 Gas hob: 60 cm
 Electric hob: 52 cm
Weight
 90 cm version: 28 kg
 120 cm version: 33 kg

Wall – 90 cm
 950 m³/h
8034122355221
Wall – 120 cm
 950 m³/h
8034122355214

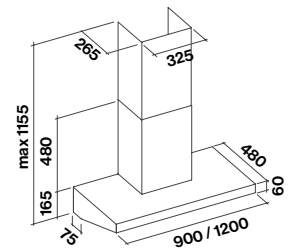



Gruppo Incasso Pro

- Scotch Brite stainless steel (AISI 304)
- Oil collector
- Electronic control
- Led lighting
- Professional baffle filters

Optional accessories

Remote control
105080053

Remote motors
List at p. 219

**Built-in – 80 cm
Motor and Control**
950 m³/h
Electronic control
3 spd + boost
Metallic filters
Baffle
Lighting
Dynamic Led Light
4x1,2 W (2700-5600 K)
Energy Class
B

Sound pressure level
Min. speed
53 dB(A)re1pW
Max. speed
64 dB(A)re1pW
**Minimum distance
from cooker top**
Gas hob: 60 cm
Elettrico hob: 52 cm
Weight
13 kg

Built-in – 80 cm
950 m³/h
8034122355177

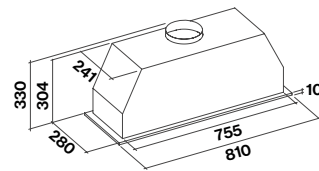

Cut-out size:
762 mm x 245 mm

Line Pro

- Scotch Brite stainless steel (AISI 304)
- Oil collector
- Electronic control
- Led lighting
- Professional baffle filters

Optional accessories

Remote motors
List at p. 219

**Island – 120 cm
Motor and Control**
950 m³/h
Electronic control
3 spd + boost
Metallic filters
Baffle
Lighting
Led 6x1,2 W (3200 K)
Energy Class
B

Sound pressure level
Min. speed
53 dB(A)re1pW
Max. speed
64 dB(A)re1pW
**Minimum distance
from cooker top**
Gas hob: 63 cm
Elettrico hob: 52 cm
Weight
42 kg

Island – 120 cm
950 m³/h
8034122355207

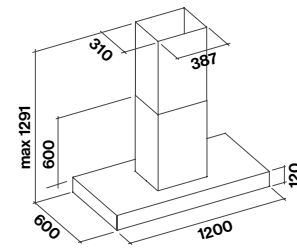

Technical notes and accessories.

Falmec air solutions.

Kitchen extraction requires an accurate assessment of your technical restraints, functional needs and particular aesthetic requirements. In addition to a wide choice of hoods, Falmec offers a range of accessories and solutions that guarantee maximum flexibility in your preferred choice of hood guaranteeing the best result every time.



Choosing the right hood.

Technical notes.

Choosing the right hood.

The study of the most suitable solution necessarily involves a preliminary assessment of the technical and aesthetic constraints of the kitchen where it will be inserted, taking into consideration multiple variables.

Distance from cooking hob.

It is suggested to respect the minimum or maximum distance between the hood and the hob, indicated in the catalog for each model.

Air Flow/Suction power.

An important point to check is the required airflow that normally depends on the size of the room and also on the frequency of use of the hood.
The correct airflow is obtained by multiplying the room volume by ten, which is the number of air changes recommended every hour. For example, for a 4x4 m kitchen with a height of 2.7 m, the following calculation should be applied: $(4 \times 4 \times 2.7) \times 10 = 432 \text{ m}^3/\text{h}$. Therefore any hood with a suction capacity of $432 \text{ m}^3/\text{h}$ will provide sufficient ventilation.

Dimensions.

To be really effective, the suction surface must cover at least the length of the hob. However, a model that is longer than the surface of the hob is recommended.

Perimeter suction.

Fumes are conveyed along the perimeter of the suction area, allowing a higher speed of the air flow and an effective performance. Falmec hoods with perimetral suction are equipped with a steel panel with a sound-absorbing material that reduces noise. This panel, easy to remove, also helps the cleaning and maintenance operations.

Pipes and ducting.

Another fundamental aspect concerns a correct installation and the use of appropriate pipes for the fumes ducting. Errors or carelessness in the installation can result in a significant drop in performance and an increase in the noise level of the hood.

Airflow friction.

The engine generates an airflow that passes through a pipe, whose walls cause friction, leading to a decrease in performance. For a correct installation and optimal functioning, it is advisable to:

- use rigid pipes with smooth walls and a diameter not smaller than the one indicated;
- avoid too long piping (longer than 7 m) and reduce the number of bends to a minimum.

Motor position.

Regardless of the position of the motor (internal, under-roof remote or external remote), the evacuated air flow will always be the same, depending on the friction that it undergoes along the ducting route. There will be a difference in pressure at the inlet and outlet of the piping, but the final result will always be the same. Therefore the installation of a remote motor (under-roof or external) does not involve any loss of performance.

Friction with walls, which depends on the characteristics of the ducting (smooth, rough).



Drawing of a circular pipe through which airflow is circulating

Friction due to curve in the ducting.



Drawing of a 90° circular bend through which airflow is circulating.

Friction due to a change in the section of the ducting (difference in diameter).

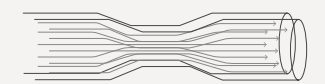

Drawing of a constriction in the pipe through which airflow is circulating.

Distance from cooking top.

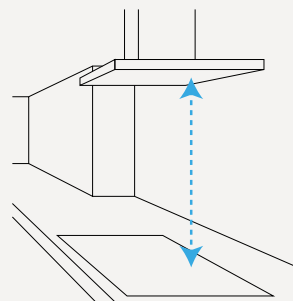

Airflow / air displacement.

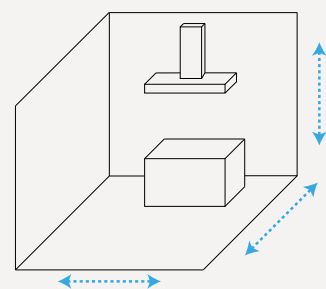

Behaviour of airflow with a remote under-roof motor installed in intermediate position.

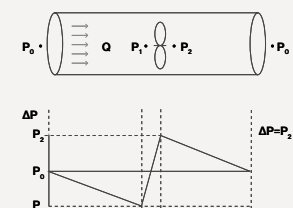

Behaviour of airflow with onboard motor.

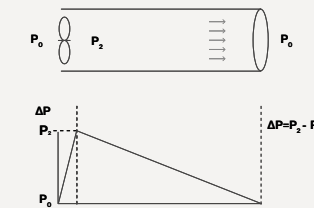

Behaviour of airflow with the motor at the end of the installation.

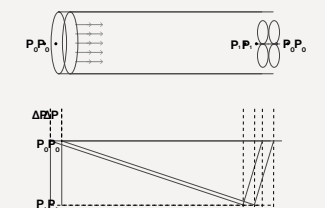

Recirculation or extraction?

Recirculation or extraction?

Each of the two installation options offers features that should be considered when choosing your hood.

Extracting Hoods.

These hoods use a fan to capture the fumes, extract them through a metal grease filter and physically take them out, together with smells and moisture.

Advantages:

- high airflow;
- humidity is conveyed to the outside;
- high efficiency even at low speeds;
- reduced noise (if the hood has been installed correctly);
- no additional cost for activated charcoal filters (and their periodic replacement).

Disadvantages:

- more complex and not always optimal installation;
- energy waste due to the extraction of the air to the outside.

*Extraction hood.
The air is channelled through piping to a flue, and from there out of your home.*

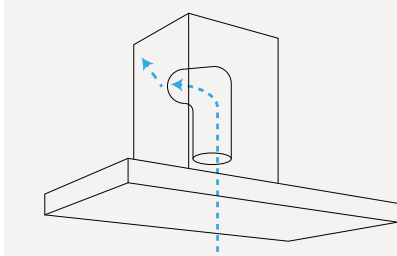

Recirculating hoods.

These hoods use a fan to capture the fumes, drive them through a grease filter and lead them towards an additional filtering area dedicated to the elimination of odors. The clean air is then conveyed back into the room. Recirculating hoods normally work in multiple filter cycles, requiring more time.

It is therefore advisable to leave the hood switched on longer (compared to extraction hoods) once the cooking operations have been completed.

Advantages:

- easy installation and flexibility in the choice of the hood;
- no additional structural work;
- significant energy savings due to the maintenance of energy in the home environment (waste is avoided).

Disadvantages (traditional filtration):

- humidity deriving from the cooking vapors is not eliminated;
- traditional charcoal filters require frequent replacement;
- generally filtering solutions are significantly noisier (phenomenon due to the non-channeled air flow outlet);
- suction flow rate is reduced by the use of traditional charcoal filters which partially obstruct the flow of air.

Filtering Innovation.

Sensitivity and attention to the quality of the air in domestic environments has led Falmecc to invest in research and development of innovative solutions in filtration and air treatment.

These largely solve the contraindications of traditional recirculating solutions, thus representing an effective and real alternative to extraction hoods.



Carbon.Zeo

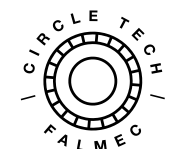

*Filter hoods.
The air passes through an active carbon filter to be purified, and is then reintroduced into the room.*

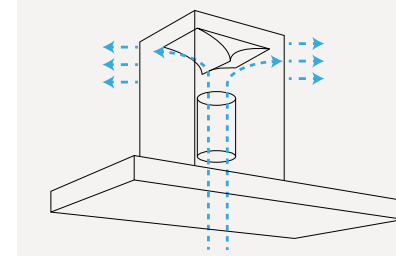

Motors.

Motors (in-hood).



800 m³/h Motors

Designed and developed to optimise fluid dynamics and consequently performance, the 800 m³/h motor represents excellent extraction capacity, at the same time as offering excellent energy efficiency (class A). The result is an extremely stable and perfectly balanced motor, thanks to its double support. The shell is created using a particular type of resin with mineral content: an innovative material that guarantees strength and solidity and reduces noise.



950 m³/h High Performance Motors

The 950m³/h High Performance motor offers even greater power to guarantee a superior extraction capacity. This motor is used in the Professional collection, a range designed to offer professional performance in a domestic setting.



Green Tech Motors

Green Tech motors use an electronic control to maximize the performance of the engine in all its phases and conditions of activity, contributing to the reduction of energy losses of the system. Moreover, the use of permanent magnets placed on the motor allows to drastically reduce the absorption of energy by the extractor hood.



Slim Motor (order separately for ceiling hoods and Down Draft)

This is a motor of compact dimensions that saves space and allows integrated hoods to be installed in extremely confined spaces. It guarantees excellent performance and excellent extraction capacity thanks to the use of an extremely efficient double axial motor. It is particularly suited to integrated models in a suspended ceiling or within the kitchen Under base, as in the Down Draft model.



Slim Motor 800 m³/h for ceiling hoods
KACL.782#49F

Slim Motor 800 m³/h for Down Draft:
KACL.784#46F

Accessories.

Remote motors.

A remote extractor fan is the right choice if you want to reduce the noise of your hood, by distancing the source of the noise, without compromising on extraction performance. Choose between a motor positioned within your home

(remote/under-roof motor) or a motor installed on an external wall (external motor). If the hood already has a motor, this can be removed before installation.

External motor units.

Falmec's external motors stand out due to their compact dimensions, superior efficiency and ease of installation. They are available as separate parts and are compatible with all models of hood with 800m³/h motors.

External extractor 1000 m³/h

1000 m³/h motor kit. 7 metre electrical cable. Suitable only for hoods with an 800 m³/h motor. Weight: 13 kg

KACL.786#41F

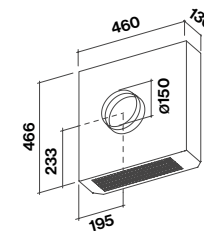
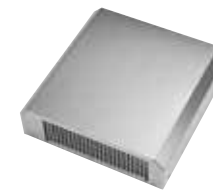

External extractor 1500 m³/h

1500 m³/h motor kit. 7 metre electrical cable. Suitable only for hoods with 800 m³/h motors. Recommended for use with 200 mm diameter pipes. Weight: 15 kg

KACL.796#4AF

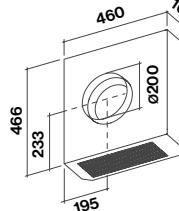

Remote in-roof/indoor motors

These units are available as separate parts for all models of hood equipped with 800 m³/h motors. They can be installed in the roof or in any space in the house.

Remote in-roof motor 950 m³/h

950 m³/h motor kit. 7 metre electrical cable. Suitable only for hoods with 800 m³/h motors (used as remote in-roof motors). Weight: 9 kg

KACL.798#41F

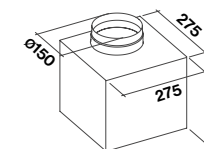

Remote in-roof motor 1100 m³/h

1100 m³/h motor kit. 7 metre electrical cable. Suitable only for hoods with 800 m³/h motors (used as remote in-roof motors). Weight: 8 kg

KACL.770#41F

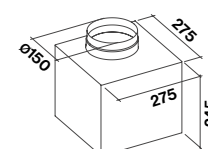

Remote in-roof motor 1300 m³/h

1300 m³/h motor kit. 7 metre electrical cable. Suitable only for hoods with 800 m³/h motors (used as remote in-roof motors). Recommended for use with 200mm diameter pipes. Weight: 14 kg

KACL.797#4AF

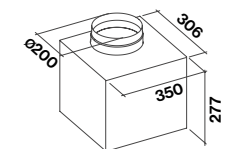

Filtration.

Anti-grease Filters.



Metallic Filters.

The anti-grease filter serves the important purpose of trapping cooking grease. Falmecc metal filters have been specifically designed to guarantee excellent grease capture. They have an internal multi-layer aluminium structure composed of corrugated mesh (to maximise the filtering surface). The frame and the external mesh are made of Scotch Brite stainless steel, a material that maintains a perfect shine over time.



Top Filters.

TOP grease filters maintain the high retention performance of the metal filters with the addition of a "chessboard" external frame in Scotch Brite steel with a smooth surface that facilitates cleaning and at the same time qualifies the aesthetic appearance.



AirFalmecc balanced filter system.

Pressure and air velocity in the extraction side of the hood are naturally greater in the areas nearest the motor. Extraction capacity will therefore be more concentrated in the central zone, directly under the extraction motor. This imbalance causes a loss of efficiency, especially in the peripheral areas of the hood. Air Falmecc balanced stainless steel filters have been created with a special diminishing honeycomb structure in which the suction holes become gradually larger the further away from the centre they are, allowing the extraction to be redistributed uniformly across the filter surface.

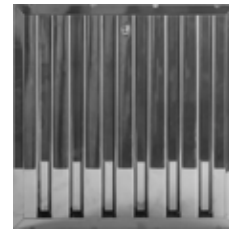

Professional Baffle Filters.

Baffle filters are fitted as standard in all hoods in the Professional collection. Adopted from the world of professional catering, their unique criss-cross structure means that oils and vapours are condensed and channelled into a suitable receptacle that can be easily removed and cleaned.

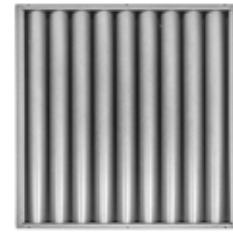

No-Drop system Filters.

No-Drop filters use innovative technology that finally solves the problem of liquids dripping as cooking vapours condense, an unpleasant and common occurrence, particularly with induction hobs. These filters arranged lengthwise have criss-cross blades and have been designed to cause cooking vapours to condense so that they can be channelled and collected in a suitable receptacle.

Anti-odour filters.

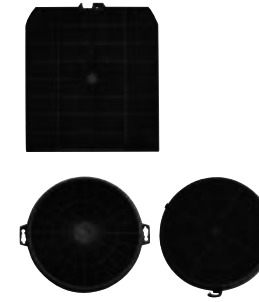

Active Carbon Filters.

Anti-odour filters are installed in all hoods that can be used in filter mode. The active carbons they contain absorb odours created by cooking. As the filters become less efficient with time, replacement at least every four months is recommended.

Type 3 (rectangular)
code 103050107

Type 2 (round)
code 103050102 (type 2) (pair)

Type 6 (round)
code 103050091 (pair)

Green Tech Ø 192 (round)
code 103050093 (pair)



Combined High Performance Filters (Silence - NRS Collection).



Wash in dishwasher with your usual detergent at a temperature not exceeding 65°C, if possible with no other contents. After washing, regenerate the filter in the oven at 80°C for 20 minutes.



Carbon.Zeo Filters.

Carbon.Zeo

Carbon.Zeo filters use natural materials such as active carbon and zeolite, a mineral of volcanic origin with a microporous crystalline molecular structure that absorbs fumes and unpleasant odours. On contact with the flow of vapours, zeolite releases heat, helping to reduce moisture caused by cooking. The Carbon.Zeo combined filter has a guaranteed minimum life of 3 years, but is expected to last 5 years under conditions of normal use. We recommend that it be regenerated every 18 months by placing it in an oven at 200° C for two hours. Carbon.Zeo technology filters outgoing air, eliminating not just unpleasant odours, but also moisture from cooking vapours through the use of natural minerals such as active carbon and zeolite.



Ionizing Element E.ion System.



New ionised components should be replaced every 5 years. For replacement information, please see the instruction booklet.

code 2x 105040271

Filtering innovation.

Technology for a better air.

Falmec offers unique, patented solutions for maximum efficiency and performance. Whether used in extracting or recirculating mode, Falmec cooker hoods satisfy one of our primal needs: breathing. Deep research, design accuracy and the use of unique, exclusive solutions allow total efficiency in operating performance, to guarantee the best air in every environment.

Our focus on air quality and environment matters has led us to develop unique technologies that guarantee all the benefits of filtering solutions without compromising on suction performance and air purity.



Accessories.

Ceiling.

Carbon.Zeo horizontal outlet ceiling filter unit kit.

These parts enable all models of Falmec extractor hood to be installed in filtration mode. The extracted air is channelled, filtered and returned to the room using a kit that can be inserted elegantly into the same false ceiling area as the hood, fitting in harmoniously with the rest of the kitchen. This solution combines aesthetic elegance with outstanding filter performance with a Carbon.Zeo filter, at the same time providing considerable energy savings.



Carbon.Zeo

Furthermore, this kit, which can be installed flush-mounted on the false ceiling, is harmoniously integrated into the kitchen environment thanks to the white painted steel frame and the white satin glass inner panel.

Filter unit
KACL.939#BF
Spare part
KACL.928

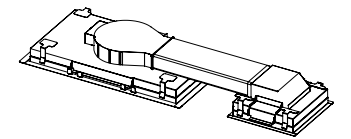
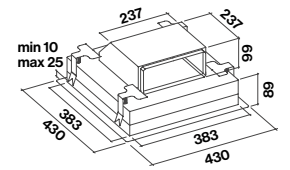

Cut-out size
396 mm x 396 mm

Carbon.Zeo vertical outlet ceiling filter unit kit.

This accessory allows the installation in the filtering version of all models of Falmec ceiling hoods that use the Slim motor in the vertical wall of the ceiling to be lowered, minimising the aesthetic impact of the outlet grid.

Filter unit
KACL.953#BF
Spare part
KACL.931



Carbon.Zeo

Filter unit
KACL.953#BF
Spare part
KACL.931

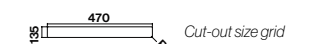
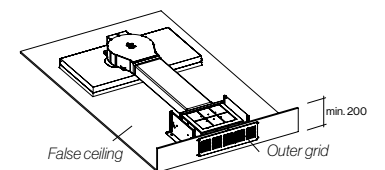
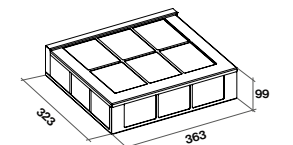

*drilling must be carried out with the template provided

Cut-out size
470 mm x 135 mm

Wall.



Filter unit for sloped hoods.

A new product designed to enhance the performance of sloped hoods installed in recirculation mode. Can be installed on the upper part of the following hood models: Quasar, Flipper (no NRS), Tab, Prisma, Diamante, Verso. This accessory can also be used with previously installed hoods to enhance performance. The unit is created in stainless steel AISI 304 or painted black.

Carbon.Zeo

Filter unit
KACL.941 (inox)
KACL.958#NF (black)
Filter replacement
KACL.943

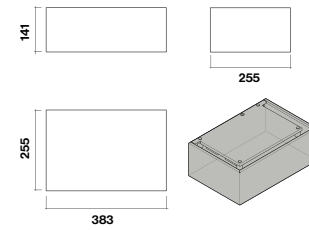

Built-in/Wall.

Filter unit for built-in hoods.

New filter kit designed to enhance extraction and recirculation efficiency in all Falmecc built-in hoods. Carbon.Zeo filters, through the use of natural minerals such as active carbon and zeolite, guarantee excellent results in filtration and at the same time reduce moisture caused by cooking vapours.

Carbon.Zeo

Filter unit
KACL.950
Filter replacement
KACL.934

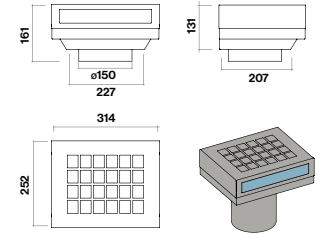

Filter unit for t-shaped wall hoods



A new filter kit designed to enhance extraction and recirculation efficiency in all Falmecc wall mounted chimney hoods. Carbon.Zeo filters, through the use of natural minerals such as active carbon and zeolite, guarantee excellent results in filtration and at the same time reduce moisture caused by cooking vapours.

Carbon.Zeo

Filter unit
KACL.948#IF*

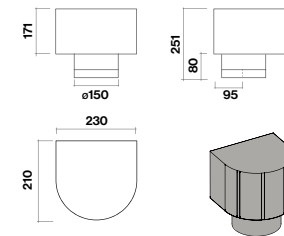

Under base.

Under base filter unit

Under base filter solutions are equipped with Carbon.Zeo technology and are installed under the kitchen plinth to enhance the filter capacity of Falmecc solutions.

Carbon.Zeo

Under base filter unit
KACL.930
Filter replacement
KACL.931

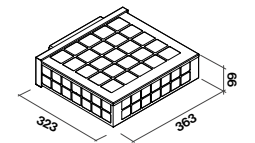

Island.

Filter unit for island hoods



New filter kit designed to enhance extraction and recirculation efficiency in Falmecc chimney island hoods. Carbon.Zeo filters, through the use of natural minerals such as active carbon and zeolite, guarantee excellent results in filtration and at the same time reduce moisture caused by cooking vapours.

Carbon.Zeo

Filter unit
KACL.949#IF*
Filter replacement
KACL.934

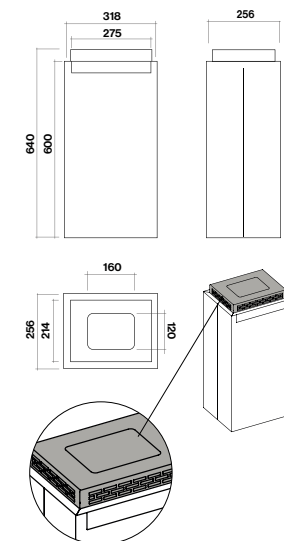

Under base Slim filter unit (h60 mm)

This solution is designed to achieve the best filter performance even in kitchens with a reduced height plinth of as little as 6cm. The solution uses filtration technology with cellular charcoal, giving a product life of 5 years. We recommend that you reactivate the filter once a year by placing it in the oven at 160° C for a hour. Filter can be regenerated up to 5 times.

Under base filter unit
slim h60mm
KACL.951
Filter replacement
KACL.952
Base grid
KACL.955

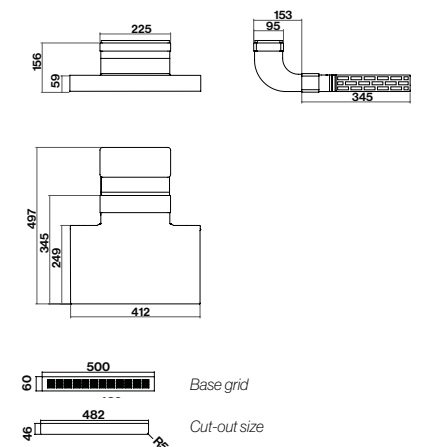

Filter chart.

Hood	Carbon filter (Spare parts)	Carbon.Zeo	
		Filtering kit	Spare parts
Alba	-	KACL.939#BF	KACL.928
		KACL.953#BF	KACL.931
Altair	103050091	-	-
Aura	KACL.935	-	-
Built-in	103050091	-	-
Blade	103050107	-	KACL.948#IF
Cielo	KACL.935	-	-
Collezione Classic	103050102	-	-
Collezione Mirabilia	103050091	-	-
Concorde	103050107	-	-
Cover	-	-	KACL.961
Dama	-	-	KACL.944
Diamante	103050091	KACL.941	KACL.943
Elios	103050091	-	-
Elle	-	-	KACL.961
Eolo E.ion	-	-	101078810
Europa	103050107	-	-
Exploit	103050107	-	-
Flipper	103050091	KACL.941	KACL.943
Flipper Green Tech	103050093	KACL.941	KACL.943
Flipper NRS	101078897	-	-
Gr. Incasso	103050091	KACL.950	KACL.934
Gr. Incasso E.ion	-	-	101078810
Gr. Incasso Green Tech	103050093	KACL.950	KACL.934
Gr. Incasso Murano	103050091	KACL.950	KACL.934
Gr. Incasso No-Drop	103050091	-	-
Gr. Incasso NRS	-	-	KACL.961
Gr. Incasso Touch Vision	103050091	KACL.950	KACL.934
Laguna	103050091	-	-
Levante	-	-	KACL.944
Light	-	-	KACL.964
Loop	-	-	KACL.944
Luce (Island)	103050107	KACL.949#IF	KACL.934
Luce (Wall)	103050107	-	KACL.948#IF
Lumen (Island 90)	103050107	KACL.949#IF	KACL.934
Lumen (Island 120)	103050107	KACL.949#IF	KACL.934
Lumen (Wall 90)	103050107	-	KACL.948#IF
Lumen (Wall 120)	103050107	-	KACL.948#IF
Lumen Island 175	-	-	KACL.961
Lumen Island 175 NRS	-	-	KACL.961
Lumière E.ion	-	-	101078810
Lumen NRS	-	-	KACL.961
Lumina NRS	-	-	KACL.961
Mare E.ion	-	-	101078810
Mira	103050091	-	-
Mira White/Black	103050091	-	-
Mizar	103050107	-	KACL.948#IF
Move/Move Green Tech	-	-	KACL.961
Nube	-	KACL.939#BF	KACL.928
		KACL.953#BF	KACL.931

Hood	Carbon filter (Spare parts)	Carbon.Zeo	
		Filtering kit	Spare parts
Nuvola Led 140	-	KACL.939#BF	KACL.928
		KACL.953#BF	KACL.931
Nuvola Led 90	-	KACL.939#BF	KACL.928
		KACL.953#BF	KACL.931
Plane (Island)	103050107	KACL.949#IF	KACL.934
Plane (Wall)	103050107	-	KACL.948#IF
Plane Green Tech (Island)	103050107	KACL.949#IF	KACL.934
Plane No-Drop	-	-	KACL.961
Plane Green Tech (Wall)	103050107	-	KACL.948#IF
Plane NRS/Plane Black NRS	-	-	KACL.961
Plane Top	103050107	-	KACL.948#IF
Plane White/Black (Island)	103050107	-	-
Plane White/Black (Wall)	103050107	-	KACL.948#IF
Polar	103050091	-	-
Polar Black/White	103050091	-	-
Polar Copper/Gold	103050091	-	-
Polar Light	103050091	-	-
Polar X	103050091	-	-
Prestige	103050091	-	-
Prisma	103050091	KACL.941/KACL.958#NF	KACL.943
Quasar	103050091	KACL.941/KACL.958#NF	KACL.943
Quasar Green Tech	103050093	KACL.941/KACL.958#NF	KACL.943
Quasar Top	103050091	KACL.941	KACL.943
Rialto	103050091	-	-
Rubik E.ion	-	-	101078810
Sirio	-	KACL.939#BF	KACL.928
		KACL.953#BF	KACL.931
Skema	-	KACL.939#BF	KACL.928
		KACL.953#BF	KACL.931
Soffio	-	-	KACL.944
Sophie	-	-	KACL.944
Spazio	-	-	KACL.944
Spring E.ion	-	-	101078810
Stella	-	KACL.939#BF	KACL.928
		KACL.953#BF	KACL.931
Stream	103050107	-	KACL.948#IF
Tab	103050091	-	-
Twister E.ion	-	-	101078810
Vega	-	-	KACL.944
Verso	103050091	KACL.941/KACL.958#NF	KACL.943
Verso NRS	-	-	KACL.959
Vetra	-	-	KACL.944
Virgola/Virgola Black	KACL.960	-	KACL.961
Virgola No-Drop	-	-	KACL.961
Virgola NRS	-	-	KACL.961
Zenith NRS	-	-	KACL.961
Zephiro E.ion	-	-	101078810

Extra-length.

For kitchens with particularly high ceilings, Falmecc offers a solution that allows you to maintain the maximum advised distance between the hood and the hob without compromising on an elegant and aesthetic result.



H 700 Wall.

Lumen - Mizar - Plane Plane
Green Tech
Stream - Luce
KACL.510#I

Exploit - Plane Top
KACL.510#X

Lumina NRS - Plane NRS
Flipper NRS
Plane No-Drop
KACL.570#I

Mirabilia
KACL.575#I

H 850.

Elios angolo
KACL.560#I

Iris
KACL.602#B

H 960 Wall.

Lumen - Mizar - Plane Plane
Green Tech
Stream - Luce
KACL.512#I

Exploit - Plane Top
KACL.512#X

Lumina NRS - Plane NRS
Flipper NRS
KACL.571#I

Mirabilia
KACL.576#I

Plane White
KACL.512#B

Plane Black
KACL.512#N

H 1200 Island.

Lumen
Lumen Island 175 - Plane
Plane Green Tech - Luce
Plane No-Drop - Elle
KACL.557#I

Exploit - Plane Top
KACL.557#X

Mirabilia 85 - Prestige
KACL.553#I

Lumina NRS - Plane NRS
KACL.572#I

Elle
KACL.557#N

Plane White
KACL.557#B

Conveyers for recirculation models.

The Conveyer (in recirculation hoods) allows better distribution of AIU, optimising airflow and reducing turbulence, which is often a cause of noise. It is only suitable for hood models with 800 m³/h motors, equipped with regular charcoal filters (type 3 or 6).

Available in three versions for wall mounted hoods and island hoods. The kit includes a tube 300mm long and 150mm in diameter to direct the air towards the Deflector.



Silencer /Conveyer NRS KACL.400



Island. KACL.866



Wall. KACL.864



Wall. KACL.865

Hoods	KACL.400	KACL.866	KACL.864	KACL.865
Altair		•		
Altair Top		•		
Collection Mirabilia		•		
Diamante				•
Europa		•		
Exploit		•	•	
Flipper				•
Flipper Green Tech				•
Flipper NRS	•			
Luce (Island)		•		
Luce (Wall)			•	
Lumen (Island 90)		•		
Lumen (Island 120)		•		
Lumen (Wall 90)			•	
Lumen (Wall 120)			•	
Lumen Island 175		•		
Lumina NRS	•			
Mira (Island/Wall)		•		•
Mira White/Black		•		
Mizar			•	
Plane (Island)		•		
Plane (Wall)			•	
Plane Green Tech (Island)		•		
Plane Green Tech (Wall)			•	
Plane NRS	•			
Plane Top			•	
Plane White/Black (Island)		•		
Plane White/Black (Wall)			•	
Prestige		•		
Prisma				•
Quasar				•
Quasar Green Tech				•
Quasar Top				•
Stream			•	
Tab			•	
Verso				•
Verso NRS	•			
Zenith NRS	•			

Ducting accessories.



Rigid flat pipe
KACL.381 150x70x1200
KACL.352 220x90x1200
KACL.331 220x60x1500



Rigid round pipe
KACL.382 ø125x1200
KACL.358 ø150x1200
KACL.340 ø200x1200



Circular/flat bend
KACL.387 ø125/150x70
KACL.371 ø150/220x90



Circular/flat connector
KACL.388 ø125/150x70
KACL.376 ø150/220x90
KACL.338 ø125/220x60



Flat junctions
KACL.383 150x70
KACL.356 220x90
KACL.333 220x60



Round junctions
KACL.384 ø125
KACL.380 ø150
KACL.342 ø200



Horizontal/flat elbow
KACL.385 150x70
KACL.367 220x90
KACL.335 220x60



Flexible ducting belt
KACL.363 ø125
KACL.364 ø150



Round bend
KACL.390 ø125
KACL.391 ø150
KACL.341 ø200



Connector
KACL.343 ø150/ø200
KACL.392 ø125/ø150



Vertical/rectangular elbow
KACL.386 150x70
KACL.369 220x90



Aluminium pipe extendable to up to 3m
KACL.359 ø125 x 800-3000
KACL.360 ø150 x 800-3000

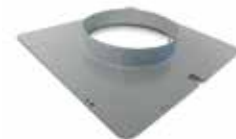

Flange for motors and high power extractor (1500 - 1300 m²/h)
KACL.396 ø200



Rectangular duct holder
KACL.389 150x70
KACL.362 220x90



Gravity wings grid
KACL.348 ø125/ ø150

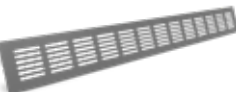

Base grid for Under base filter h60 mm
KACL.955 500x60

Operation and maintenance.

Remote control.

In order to operate all its ceiling models in maximum comfort, Falmec offers free remote control with a display that allows you to manage the different functions of the hood.

105080053

Turning on and using the hood.

We recommend that you turn on the hood a few minutes before beginning to cook, and that you turn it off several minutes after you have finished. This guarantees the maximum efficiency in the extraction of cooking fumes and steam.

Remote commands	
	UP Turn on motor and increase speed from 1 to 4. The fourth speed operates for just a few minutes at a time.
	DOWN Decrease speed and turn off motor.
	Light ON-OFF Turn the light on or off.
	TIMER ON: Automatically turn off the motor after 15 minutes. The function automatically deactivates if you turn off the motor (button)
	Ongoing transmission

Maintenance.

The internal duct should be cleaned once a year. The filters require a different procedure: for metallic anti-grease filters a cycle in the dishwasher at 45°C is sufficient. This should be done as and when required. Carbon filters should be replaced every four months. High Performance carbon filters should be washed in the dishwasher at a temperature no higher than 65°C, if possible with no other items. After washing, they should be reactivated in the oven at 80°C for 20 minutes. Carbon.Zeo filters should be reactivated in the oven at 150°C for approximately an hour every 18 months. They should be replaced every 3 years. Ionising elements should be replaced every 5 years.

Steel cleaning.

Falmec uses only materials of the highest quality to create its hoods. For this reason it is important to care for them using the most suitable products, in order to guarantee a perfect finish and long-lasting wear. For models created in stainless steel, Falmec has created unique cleaning wipes that give extra shine to your hood. They are impregnated with a special mix of oils that prevent dirt particles from being deposited and prevent fingerprints marks, giving a clean, shining finish. The hood can be washed with hot water and a neutral detergent. Once dry, simply wipe down with Magic Steel wipes in the direction of the satin finish, buff with a soft cloth (still in the direction of the finish) and leave to dry.

Magic Steel protective wipes for stainless steel surfaces.

KACL.815 (box 10 pz)



Ceiling hood installation options.

Falmec ceiling hoods guarantee elegance, minimalism and superior extraction efficiency (in both extraction and filter modes) using the most suitable motor and exclusive Carbon.Zeo ceiling filter kits. Falmec's solutions are intelligent and flexible, making installation easy.



Watch our video tutorial on ceiling hood installation in extracting mode.



Watch our video tutorial on ceiling hood installation in recirculating mode.

Hood-top motors.

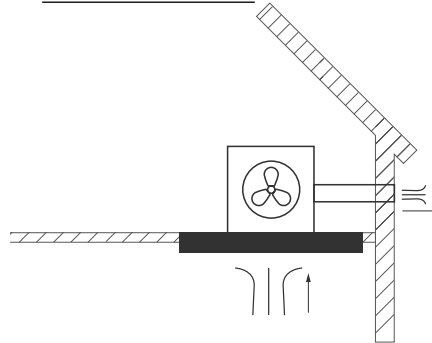

Motors installed on the hood

KACL.798#41F - 950 m³/h
KACL.770#41F - Brushless 1100 m³/h
 Use with 150Ø pipes

Internal in-roof motor.

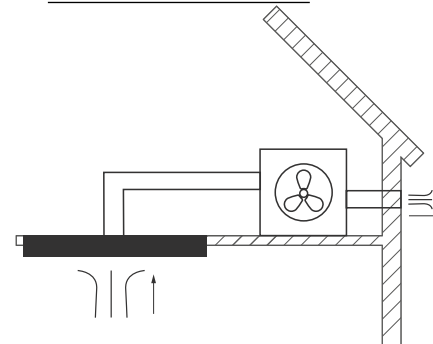

Internal in-roof motor with round ducting

KACL.798#41F - 950 m³/h
KACL.770#41F - Brushless 1100 m³/h
 Use with 150Ø pipes

KACL.797#4AF - 1300 m³/h
 Use with 200Ø pipes and flange (KACL.396)

Ceiling hood installation options.

External extractor.

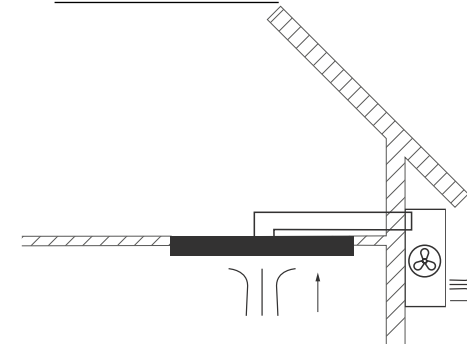

External extractor with round ducting

KACL.786#41F - 1000 m³/h
 Use with 150Ø pipes

KACL.796#4AF - 1500 m³/h
 Use with 200Ø pipes and flange (KACL.396)

*The external extractor fan must be positioned protected from atmospheric agents.

Recirculating mode.

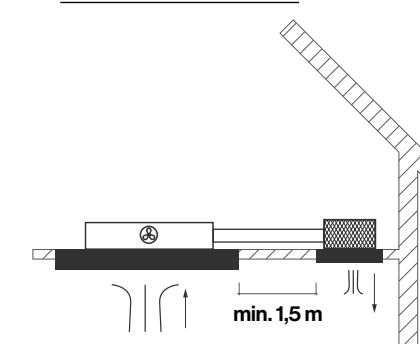

Slim motor with Carbon.Zeo filter unit.

KACL.782#49F - Slim 800 m³/h
 Use with flat 220x90mm pipes

KACL.939#BF - Carbon.Zeo Filter Kit

Adjustable direction air outlets.

Standard motor unit
 5 directions

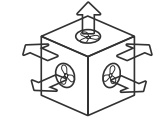

Slim motor unit
 4 directions
 (according to motor placement)

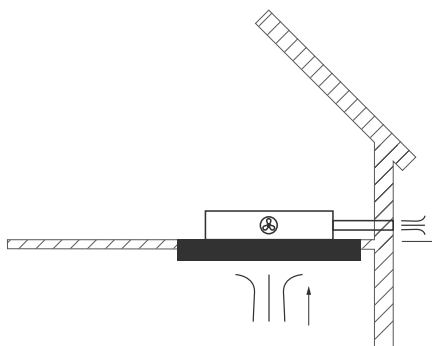
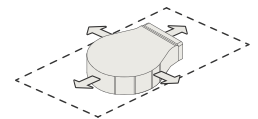

Slim motor installed on the hood

KACL.782#49F - Slim 800 m³/h
 Use with flat 220x90mm pipes

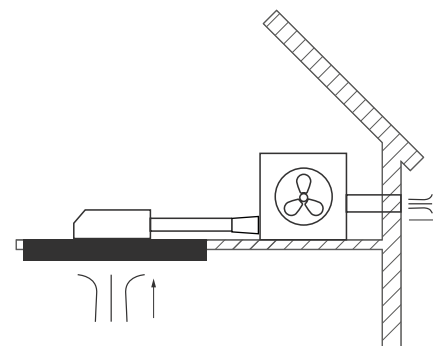

Indoor in-roof motor with flat ducting

KACL.798#41F - 950 m³/h
KACL.770#41F - Brushless 1100 m³/h
 Use with flat 220x90mm pipes

Important: if flat ducting is used you will need KACL.789 and KACL.376 junctions.

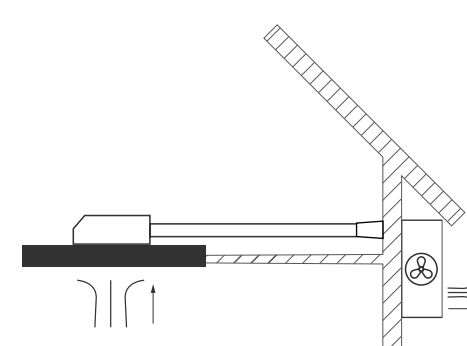

External extractor fan with flat ducting

KACL.786#41F - 1000 m³/h
 Use with flat 220x90mm pipes

KACL.796#4AF - 1500 m³/h
 Use with 200Ø pipes and flange (KACL.396)

Important: if flat ducting is used you will need KACL.789 and KACL.376 junctions.

*The external extractor fan must be positioned protected from atmospheric agents.

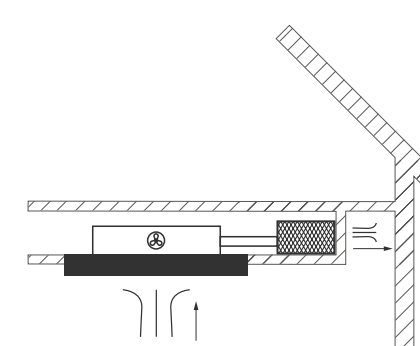

Slim motor with Carbon.Zeo vertical filter unit

KACL.782#49F - Slim 800 m³/h
 Use with flat 220x90mm pipes

KACL.931#BF - Vertical Carbon.Zeo filtering kit

Junctions.

Flange
KACL.396
 ø200

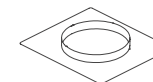

Junction
KACL.789
 220x90 mm

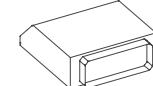

Round/rectangular junction
KACL.376
 ø150/220x90

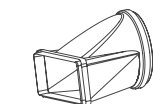

Piano hood installation.

Motors.

KACL.701#41F
1.000 m³/h

Under base motor for single element Piano hood.

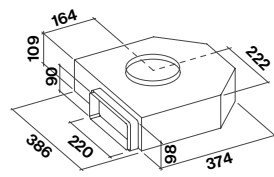

Installation example: single element Piano hood junction and Under base motor with left side air outlet.

KACL.701#41F + KACL.760

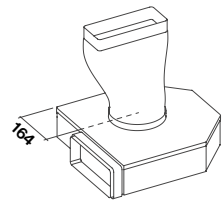

Conveyers/junctions.

KACL.760

Single element Piano hood Conveyer, left side outlet.

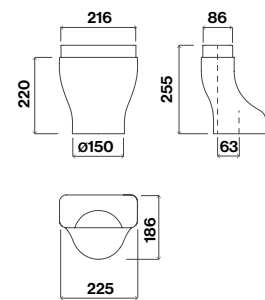

KACL.761

Single element Piano hood extended depth Conveyer with right side outlet.

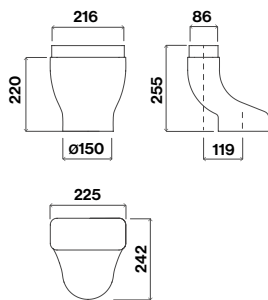

KACL.345

Double horizontal elbow

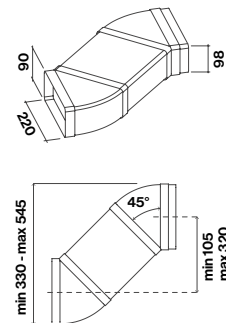

Altair Top - Laguna.

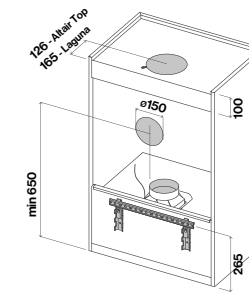

Diamante.

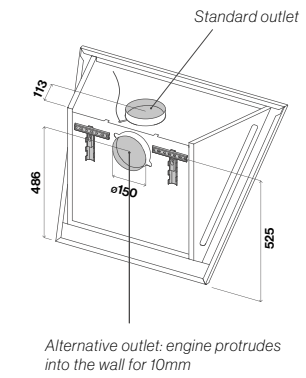

Flipper - Flipper Green Tech.

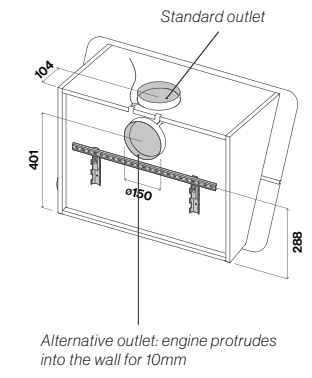

Flipper NRS.

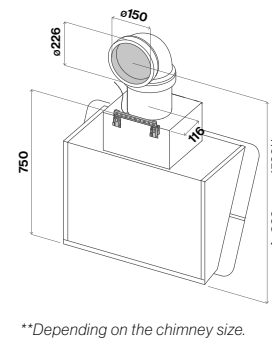

**Depending on the chimney size.

Lumina NRS - Plane NRS.

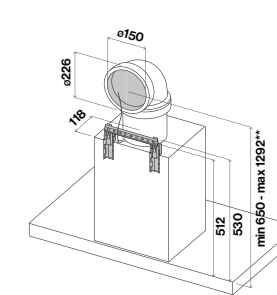

Mirabilia Round.

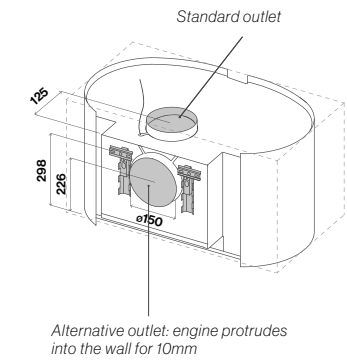

Mira.

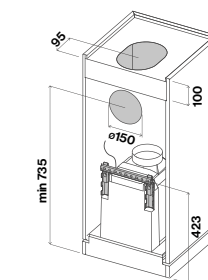

Move.

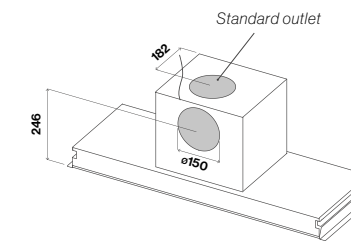

Prisma.

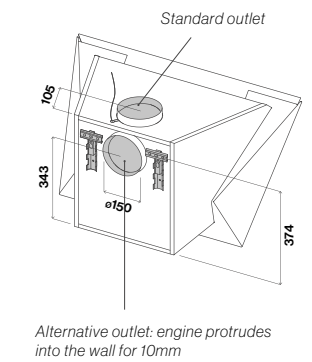

Life inspired.

**Quasar - Quasar Top
Quasar Green Tech.**

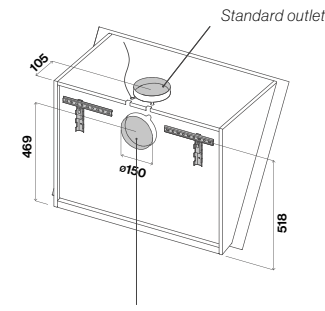

Alternative outlet: engine protrudes into the wall for 10mm

Rialto h100.

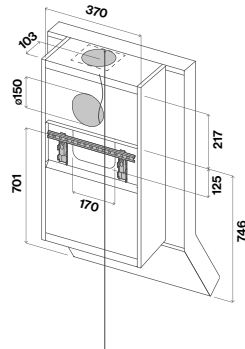

Upper outlet: remove 165x165 mm patch.

Rialto h82.

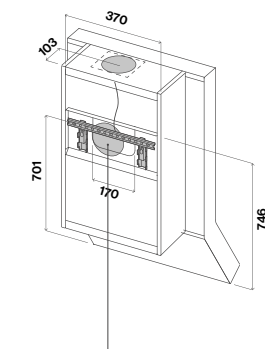

Rear outlet: remove 170x125 mm patch.

Life inspired.

Zeus Pro.

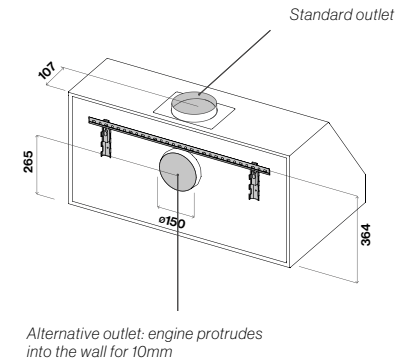

Alternative outlet: engine protrudes into the wall for 10mm

**Polar - Polar Light
Polar White/Black.**

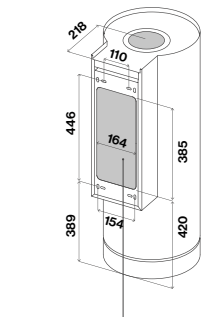

Rear outlet: remove 385x164 mm patch.

Prestige.

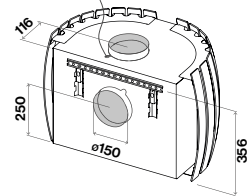

Verso.

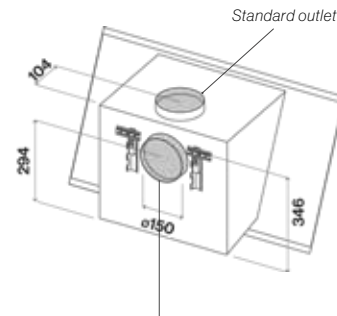

Alternative outlet: engine protrudes into the wall for 10mm

**Exploit - Mizar - Plane - Plane Top
Luce - Plane White/Black - Plane Green Tech.**

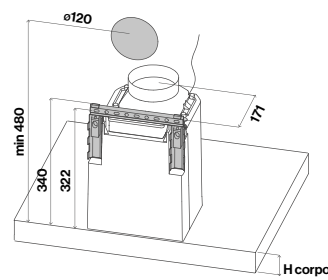

Versions 600 m³/h

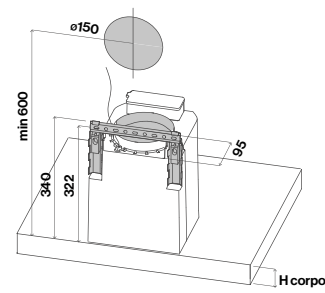

Versions 800 m³/h

Virgola.

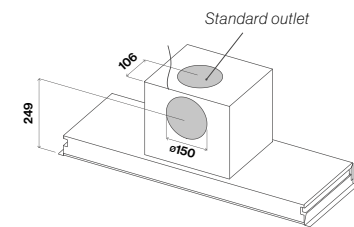

For other technical informations about products installation, please visit falmec.com

Life inspired.

Falmec declines all responsibility for any inaccuracies contained in this catalogue that are due to typos and copying errors. This catalogue supersedes and replaces all previous ones.

Falmec Spa hereby reserves the right to make - at any moment and without prior notice - all the technical, aesthetic and functional alterations to the products that it believes necessary for their improvement.

Models, images and technical solutions presented in this catalogue are protected by industrial property rights.

The printing process do not always permit a faithful reproduction of tones and materials of original.

This catalogue is the exclusive property of Falmec Spa. All rights are reserved. Any form of total or partial reproduction of this catalogue is strictly forbidden.

Life inspired.



Life inspired.

Falmec S.p.A

**via dell'Artigianato, 42 z.i.
31029 Vittorio Veneto
Treviso — Italy
info@falmec.com
falmec.com**

Credits

Photo
Contratti Company
Eye Studio
Nudesign
Lalavatriceblu

Stylist
Vanda Gemino
Eye Studio

Copy
Dana Cukier
Daniele Varelli
Claim Brand Industry

Graphic design
Designwork

Falmec S.p.A

**via dell'Artigianato, 42 z.i.
31029 Vittorio Veneto
Treviso — Italy
info@falmec.com
falmec.com**